

HOME COMPUTING WEEKLY

AN ARGUS SPECIALIST PUBLICATION

September 17-23 1985 No 130 50p

CHOP SUEY
 THE KUNG-FU CHALLENGE!
 For ATARI 400/800/600 XL/
 800 XL/130 XE—48K—
 Cassette £8.95. Diskette £12.95
 from
ENGLISH SOFTWARE
 ENGLISH SOFTWARE
 ENGLISH SOFTWARE

There's no business like show business

The 8th **Personal Computer World Show**

Special reports inside...

Win a trip to the TV studios in the

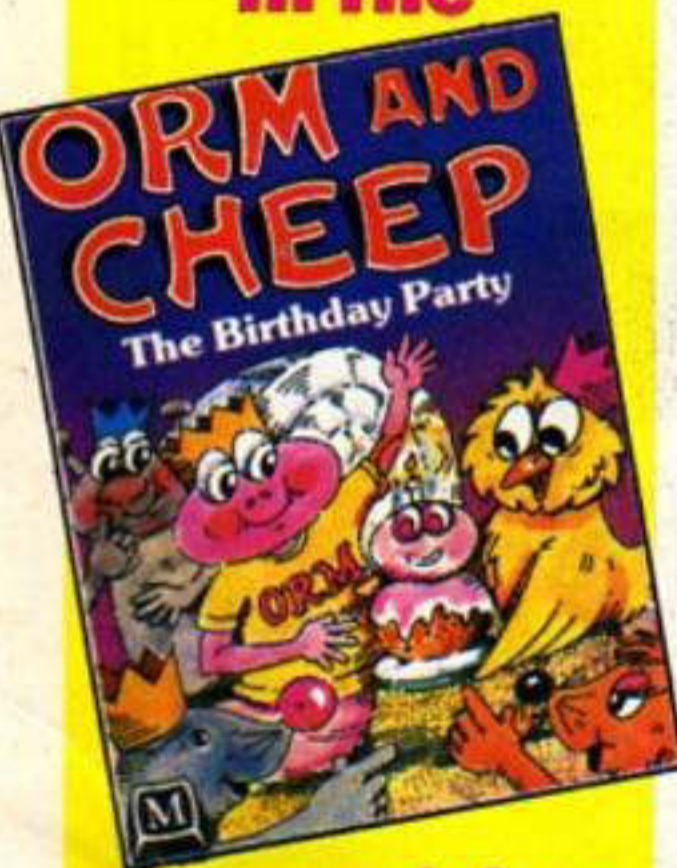

competition from **Macmillan Software**

Soft Aid II after Xmas



Plans are well advanced for another charity compilation tape in aid of Ethiopia like the immensely successful Soft Aid collection which broke all records earlier this year.

Rod Cousens, who masterminded the first tape, told HCW that he had plans for another tape but that it is unlikely to be released before Christmas as there are already a number of compilation tapes launched for the Christmas market.

The detailed composition of the tape has not yet been confirmed but Rod already has commitments from a number of the leading software houses to donate products. There are likely to be four versions of the new compilation, with Amstrad and BBC being added to Spectrum and Commodore. Rod also confirmed that there will soon be a disc version of the first Soft Aid collection for the American market.

Estimates of the amount raised differ slightly but Rod believes that around £300,000 will be paid by Micro Dealer UK, the sole distributor, to the Band Aid appeal. The first part of this sum, £150,000, was passed to the appeal fund a couple of months ago.

"I would like to see the software

industry raise a half million pounds by the end of the appeal," said Rod. "We have already raised three times the original target and all involved are to be congratulated."

Despite the large amount raised, there is some concern over the project.

Earlier this year Tiger Distribution, who supplied goods to the newsagent multiple John Menzies, went into receivership—and their debts included non-payment for a large number of Soft Aid tapes.

Menzies had a sale or return agreement with Tiger which allowed the newsagent group to return any tapes, including Soft Aid, which didn't sell. This meant that although Tiger had distributed a large number of Soft Aid tapes to Menzies and other retailers there were insufficient assets to pay for the goods when Tiger ceased trading.

Another slight concern is that the money raised for the appeal, by the sale of tapes, is currently in Micro Dealer's normal trading account. This is "normal practice" according to Band Aid's accountant Phillip Rusted but he added that it "would be more appropriate for the money to be held in a separate deposit account, so that the interest goes to the Band Aid Trust. This has certainly been done in the case of similar enterprises."

The accounts are "fully available to any auditors" according to Rod Cousens, a sentiment echoed by Neil Johnson, joint managing director of Micro Dealer UK who "would welcome an audit of the Soft Aid project."

The public can have confidence, according to John Kennedy, Band Aid's lawyer, who claimed that "Band Aid can take steps to make sure that no one else benefits from the appeal."

The project was such a success that it caused the companies who were handling it some difficulties.

Neil Johnson told us about the costs



● Rod Cousens—Soft Aid's creator

that had accrued and admitted that "in retrospect it has proved to be a huge administrative burden. We were chosen because we could get the tapes out quicker but it has cost Micro Dealer a great deal."

With a new tape in the offing for early next year and the news that the original Soft Aid tape is still selling both here and abroad, Rod is certain that this "magnificent effort by the computer software industry" will reach his new target of £500,000 within the foreseeable future.

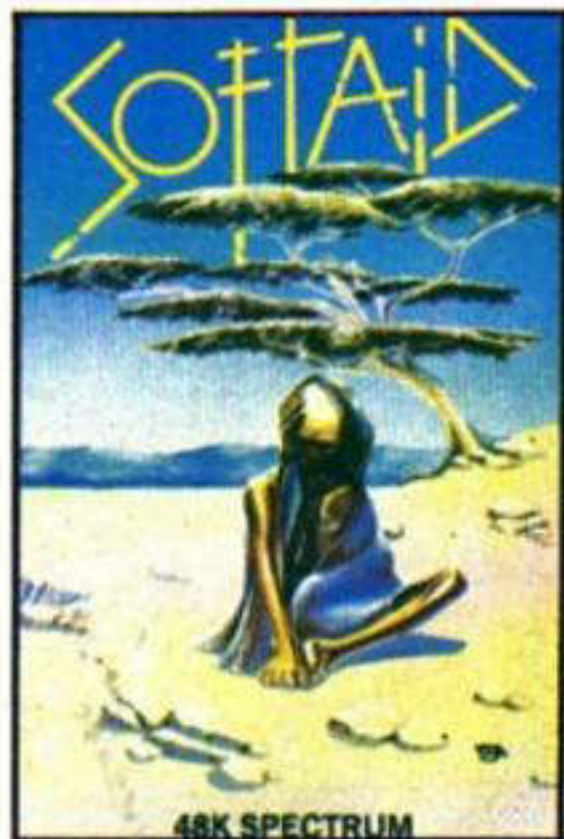

48K SPECTRUM

Toshiba's Ideal Home of the future p.32

Dungeon update—Ventures p.14

Into the Valley of Nidd-Slomo p.17

6 pages of software reviews p.18

Programs for Spectrum, BBC C64 and Amstrad

MIRROSOFT

SEPTEMBER SIZZLER!

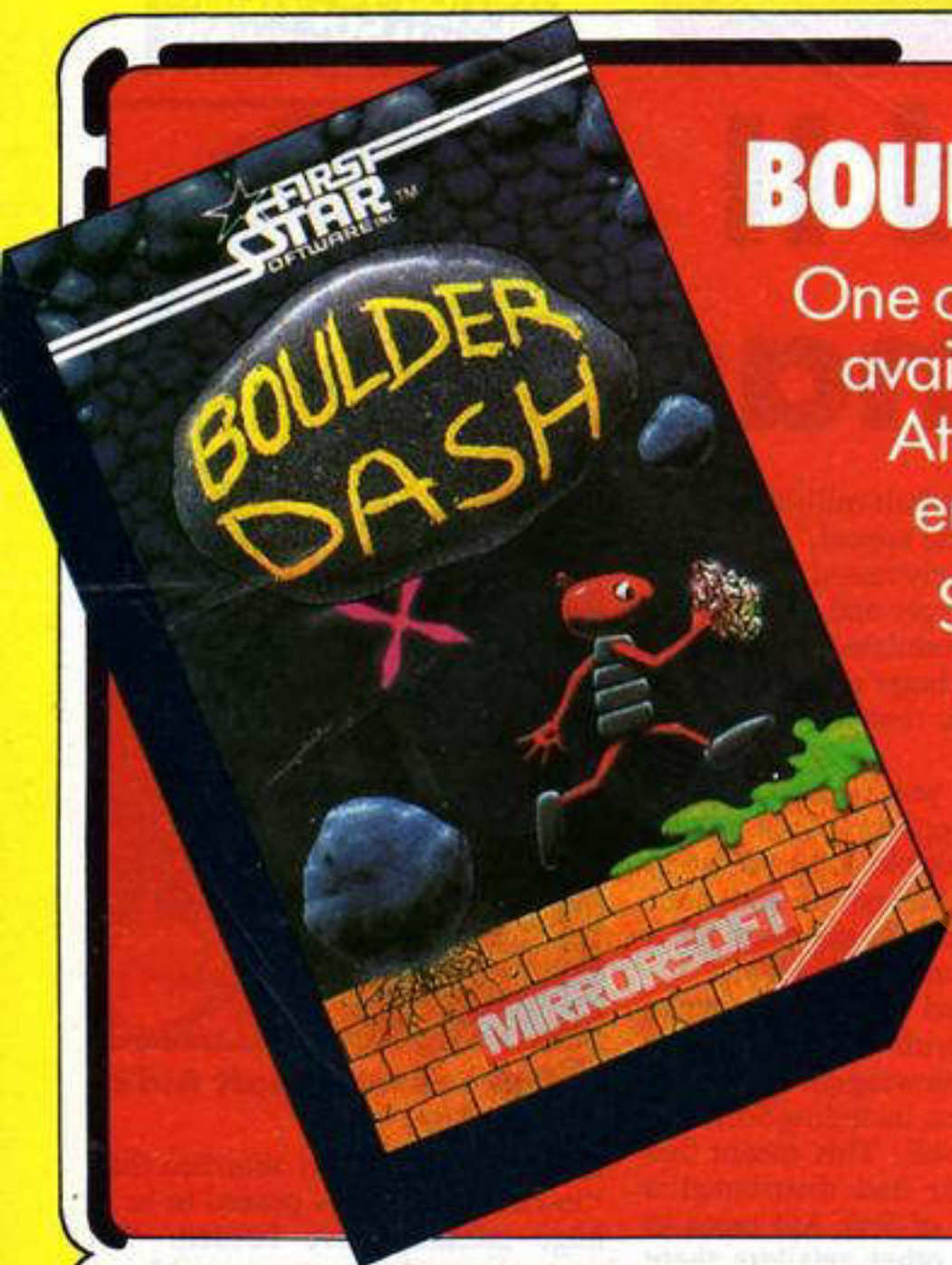

BOULDER DASH

One of the great classic games of all time is now available to even more of you – Amstrad and Atari owners everywhere can now experience the ultimate underground journey.

Search through the 16 caves, each with 5 levels of difficulty, and collect as many jewels as quickly as possible. Don't forget to block the amoebas, transform the butterflies, or outmanoeuvre the fireflies – or you'll never get out alive!

Available September 5th

Amstrad CPC464 and Atari 48K versions back-to-back on one tape at £9.95.

ASHKERON!

'Ashkeron is something for everyone: a complex, challenging, witty game for the adventurer, and its got pretty pics for the zap'em crowd. An excellent game – buy it! – *Home Computing Weekly*

'It is highly professional, sophisticated software... in its walls lies a challenge everyone will find interesting and rewarding' – *Crash Micro*

'This game gets my royal assent' – *Your Spectrum*

'A charming graphic adventure' – *MicroScope*

Available now for
Amstrad CPC464 £6.95
Spectrum 48K £5.95

With built-in competition!

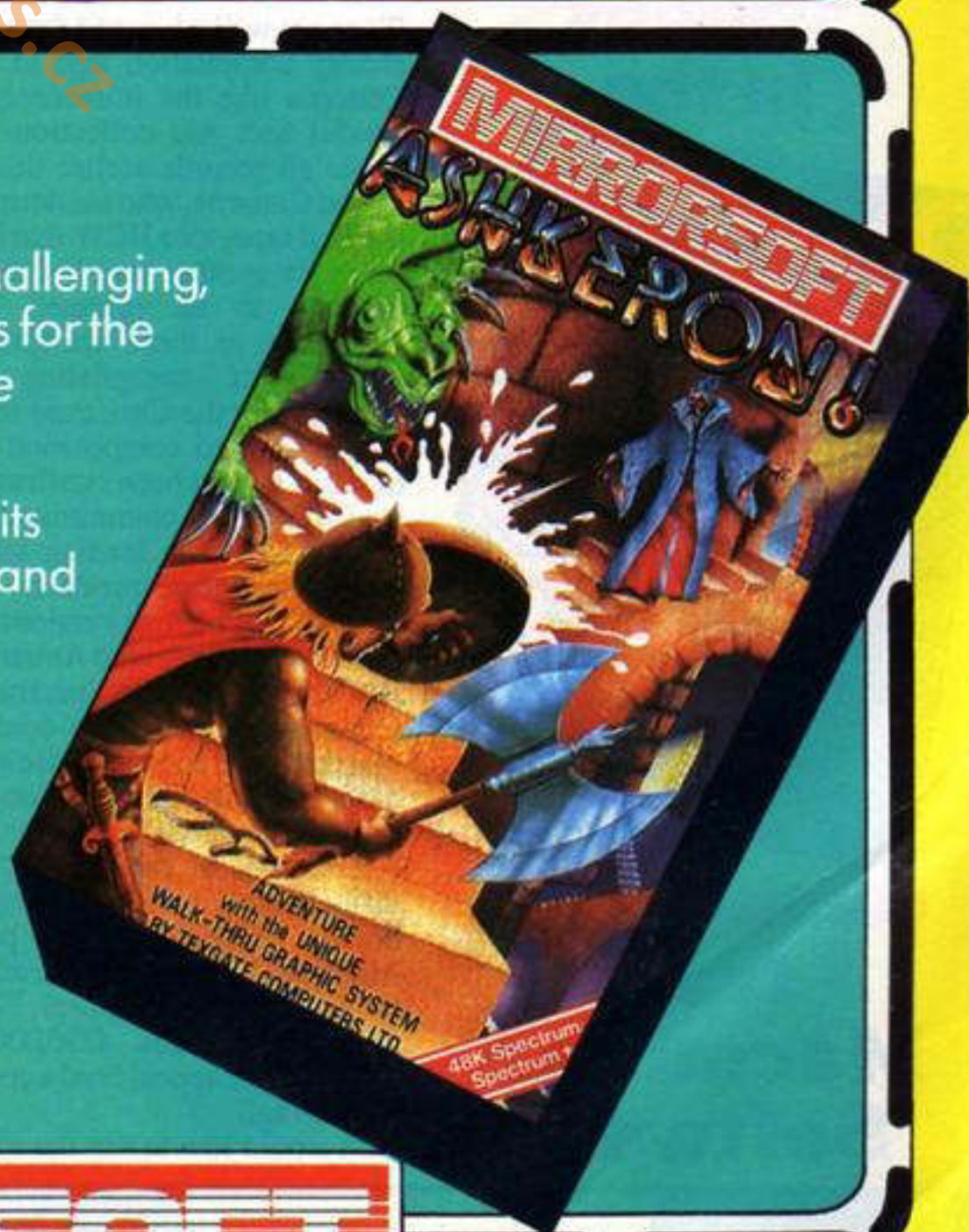

MIRROSOFT

Maxwell House, 74 Worship Street, London EC2A 2EN
Trade orders to: Purnell Book Centre, Paulton, Bristol BS18 5LQ

The 8th
**Personal
Computer**
World
Show

HOME COMPUTING WEEKLY

September 17-September 23, 1985 No. 130

HENRY'S HOUSE
...and friends!!
VOLUMES ONE AND TWO
C64 COMMODORE C128
COMING SOON!

Soapbox

The arguments about the harmful effects of TV and film violence on the viewing public are well aired but I think it is about time that concern was expressed about the level of violence in computer games.

The worrying difference between TV and computer game violence is that the player is actively involved with the decimation of increasingly realistic people. He is not just a passive onlooker staring at a screen.

Games like Beach Head 2 encourage the player to destroy as many soldiers as possible and rewards them with horribly realistic sound effects of agonised death throes. It's about time the software houses faced up to their responsibilities and devised better uses for their software expertise, rather than produce games that involve the wholesale massacre of human beings.

In the early days of gaming, death was something that happened to vague blobs that were referred to as "aliens" now it's getting all too real. And as the graphics and sound effects are certainly going to become even more sophisticated in the future it will become even more realistic. Will the young gamers of today be able to tell the difference between real violence and violence with pretty graphics on the screen?

M.A.W.

SPECIAL FEATURES

Software Releases —
all the games at the show8

Ventures — more adventure hints and tips .14

Show impressions —
our reporters give you the low down26

Future Home — Toshiba's crystal ball32

AMSTRAD

It's a game — programming tutorial24

BBC

Chicken Feed — game program29

COMMODORE

High Roller — game program28

Coming soon...

- Firming up on the Beeb — Watford's Romspell
- Spotting the swots — McGraw Hill's Ladders to Learning
- Computer Concepts with Intersheet
- Ron meets Rambo...

SPECTRUM

Text Effects — utility program12

PERIPHERALS

Slomo from Nidd Valley17

REGULARS

Book reviews5

News — it's all here.....6

Software releases8

Ron Complex — a continuing saga16

Software reviews — six pages this week18

Your letters38

Orm & Cheep competition37

Readers page — more high scores38

Editor Dave Carlos
Assistant Editor Bryan Ralph
Editorial Assistant Kerry Fowler
Group Editor Wendy Palmer
Design Tony Keep
Production Assistant Lyn Collis
Ad Manager Dominic Forlizzi
Classified Advertising David Horne
Publishing Director Peter Welham

Argus Specialist Publications Ltd.

No. 1 Golden Square, London W1R 3AB. 01-437 0626

Home Computing Weekly is published on Tuesdays. Subscriptions and back issues: Infonet Ltd, 10-13 Times House, 179 Marlway, Hemel Hempstead, Herts HP1 1BB. 0442 48432. Trade distribution: Argus Press Sales and Distribution Ltd, 12-14 Paul Street, London EC2A 4JS. 01-247 8233. Printed by Alabaster Passmore & Sons, Ltd. of London and Maidstone, Kent. Design and origination: Argus Design Ltd, Circus House, 26 Little Portland Street, London W1N 5AF.

BASIC LIVING

Jim Barker/Jon Wedge



Beyond Your Wildest Dreams

An amazing new concept in software presentation, Electric Dreams will bring you two exciting games in one double size cassette package at the superb value for money price of **ONLY £9.95 on cassette and £12.95 on disk.**

Some of the world's most ingenious minds will be recruited to bring you entertainment and excitement beyond your wildest dreams.

Buy this title as the first of many to complete your range of Electric Dreams.

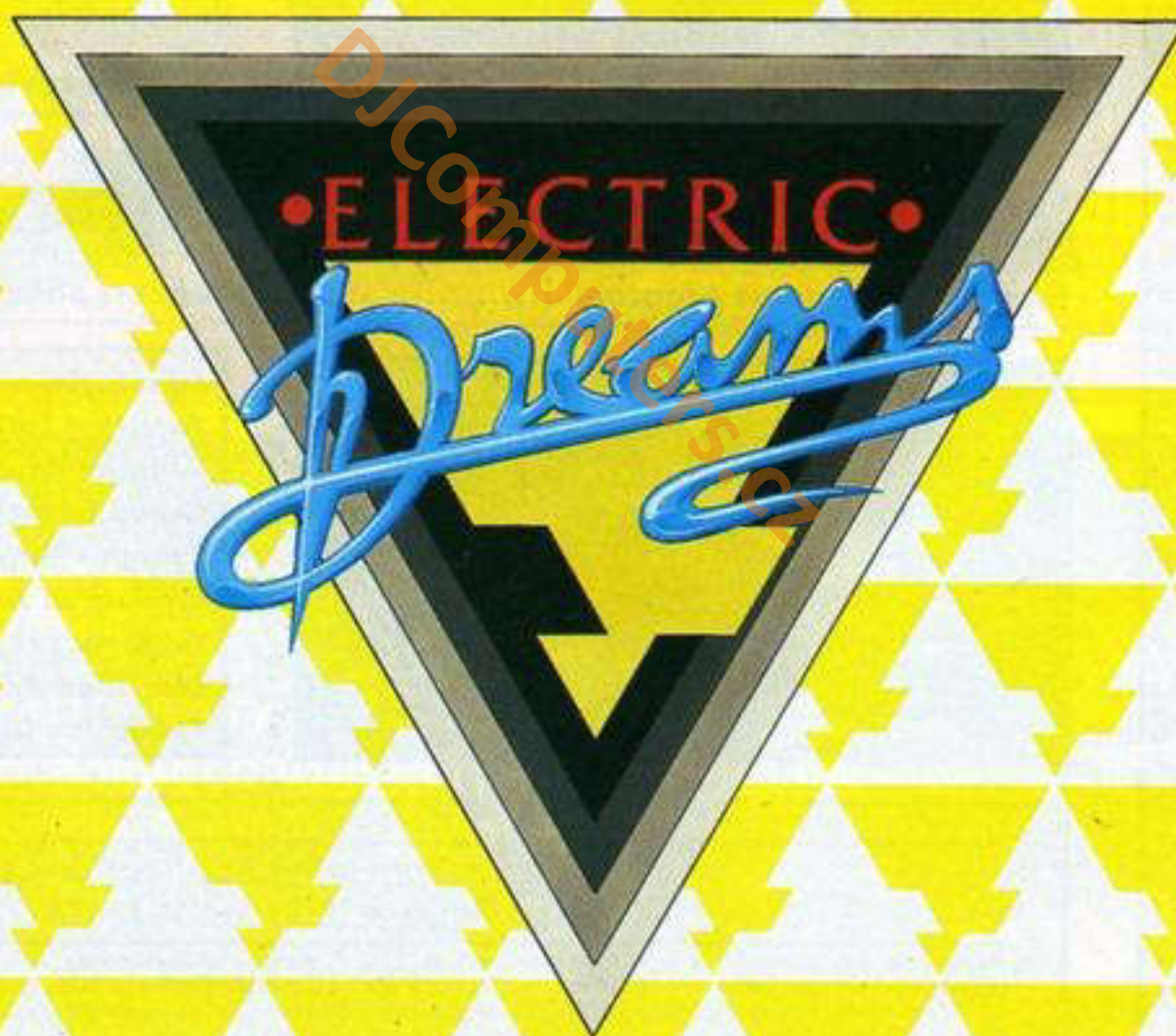

Digital dexterity and devious deduction are only two of the skills you'll require when you take on the nasty bad men in these two episodes from the world's most intriguing espionage story.



Spy's Demise



Spy Strikes Back

Available on Commodore 64 and Atari

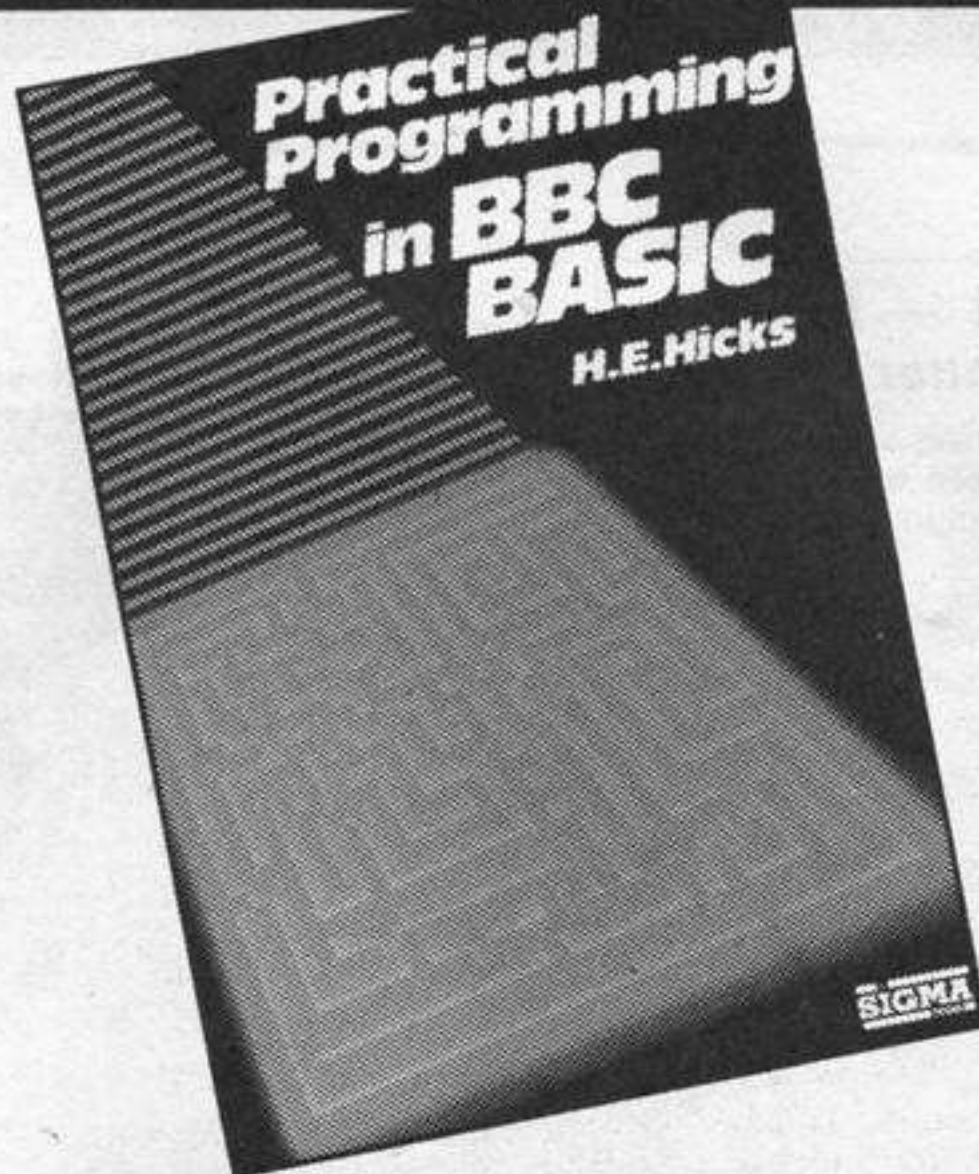

Practical Programming in BBC BASIC

Although BBC BASIC and the micro's built-in assembler actively encourage users to not only program but program easily, there is still a great need for books to aid the novice programmer.

A large number of such books exist, certainly, but most of them probably lie unread soon after purchase. To be useful, a programming book must offer more than a few "off the cuff" routines. Hicks' book delivers.

Although it provides a collection of programs, these are useful as examples — in contrast to the more usual attempt to include even the shortest and most boring routines in order to proclaim "over 100 programs!" or whatever on the cover. None of the programs are worth buying the book for, however, but serve as examples of programming as a series of problems to be solved.

Designing a program has to begin on paper — working out the steps to a solution is vital. The "proper" way to do this is via flow charts and, despite the desire to get working at a keyboard, their use is vital to save wasted time. Now many beginner's books advocate the use of flow charts; many show how to use them but I don't recall one before that flow charted entire programs in

detail and tied the actual program writing back to the chart and the final program lines to boxes and flow lines. This book takes such an approach and it is both interesting and instructive.

A flow chart is a visual representation of the serial execution of instructions — each instruction is pointed to from boxes via arrows. The very act of committing the structure to a flow chart imposes a certain pattern and flow and, of course, this ties in very nicely with BBC BASIC's use of procedures. Whilst most flow charts in books take the form of "Start Initialise Execute End", Hicks' title takes you down to real detail. Detail, it need hardly be mentioned, that you'll need to work out in even the simplest of your own programs — nothing writes itself! It is helpful, to say the least, to see someone take you through all the steps in this way.

The book also discusses formal languages as design aids, numerical techniques and turtle animation graphics. In short, if you want a good solid basis for your future programming on the BBC, then you could do a lot worse than pick this up.

"Solid", though, is a carefully chosen word — the book's style is a little dry and so may be suitable only for the more mature Beeb owners. Teachers in particular, could use this book with profit. **D.R.**

Price: £6.95

Publisher: Sigma Press

Address: 5 Alton Rd, Wilmslow, Cheshire SK9 5DY



Spectrum Shadow ROM Disassembly

This explanation of the Sinclair ZX Interface 1 ROM follows the style of previous Melbourn House disassemblies for the Sinclair machines, but starts with very useful BASIC extension routines. They consist of a number of machine code routines, each of which makes up a new BASIC command. These include a double POKE, POKE strings, memory dump, direct EDIT, improved BEEP, faster and more complete CAT command, pseudo-random file handling and adding data to a file. Users of serial printers will find the extended RS 232 channel command will support TAB and comma on the printer and provide other useful printer commands.

The routines are given as a decimal dump with BASIC loader, as well as in assembler and so can be used by readers with no machine code knowledge. More ambitious programmers will find numerous hints in these examples for utilising the facilities of the Interface 1 ROM in their own routines.

The disassembly is well documented and all the instructions are fully addressed. It includes network, microdrive and RS 232 link routines. The 11 appendices cover comprehensive indices of ROM routines and labels, sorted numerically and alphabetically, as well as the changes in the edition 2 ROM.

As books of this type go, this one is very readable and easy to use. It will be of particular interest to machine code programmers but is worth buying simply for the example BASIC extensions.

Price: £8.95

Publisher: Melbourn House

Address: Castle Yard House, Castle Yard, Richmond TW10 6TF

BBC



SPECTRUM



NEWS

Eureka! — its a winner

The Eureka! prize, a cheque for £25,000, has been won by a 15 year old schoolboy, Matthew Woodley.

In order to get to the prize Matthew had to complete all the parts of the adventure game and decipher the clue to find a telephone number. After dialing the number an answering machine asked you to explain why you had rung.

It appears that Matthew rang the number a few times before making his claim for the prize but he was quite happy to receive his giant cheque from Domark's directors Dominic Wheatley and Mark Strachan.

The other 99,999 hopefuls who are still playing the adventure should note that the number has now been disconnected and there are no second prizes on offer.



Smiles all round — Matthew's cheque

Domark, 204 Worplesdon Rd, London W20 8PN

More play less work

To alleviate the beginning of term blues, CGL have some natty little robots which double as rubbers to erase those inevitable mistakes.

Also in the Switchbot range (now there's a name to conjure with) are a two-colour pen

robot and Sharbo which to get straight to the point, is a robotic pencil sharpener.

Sorry to harp on about Christmas, but at £1.99 these could also make rather sweet adornments for the tree.

CGL Hse, Goldings Hill, Loughton, Essex IG10 2RR



Robotic stationery from CGL.

Facing the Future

Well it seems that all your hard labour sweating it out on paper rounds and in greasy cafes has been bumping up the coffers of the software industry.

According to market research carried out by Mintel publications the £100 million computer games market is definitely on the increase with 17 million units expected to have been sold by the end of 1985.

However, as we all know all good things come to an end and the incredible boom in sales is expected to level out in the next two years and with fewer software publishers dominating the market.

In contrast video games sales have nearly halved from 46 million to £25 million in 1984 and are expected to fall to £16 million by the end of the year.

Discs will be the medium of the future and the trade up from cassette recorders to disc drives will be inevitable. The trend towards more sophisticated, powerful machines is also a natural progression as users become more demanding of games' capabilities.

As enforced leisure time grows with unemployment, TV games are going to be with us a long time, and hopefully the nature of games playing will continue to be more constructive — rather than simply time-filling.

Food for thought

As we all know marketers are well-practised in designing a consumer to suit his product. Working on the principle that "most people associated with computers are lean, hungry go-getters" Nigel Murphy of 3M has included a free copy of Egon Ronay's "Just a Bite" to anyone who buys two 10-disc boxes of 3.5 inch and 5.25 inch diskettes.

There are bytes and bites . . .

No doubt next year will bring free copies of "Fight the Flab" to counteract the effects of over-gourmandising.

3M, 3M Hse, Bracknell, Berks RG12 1JU.

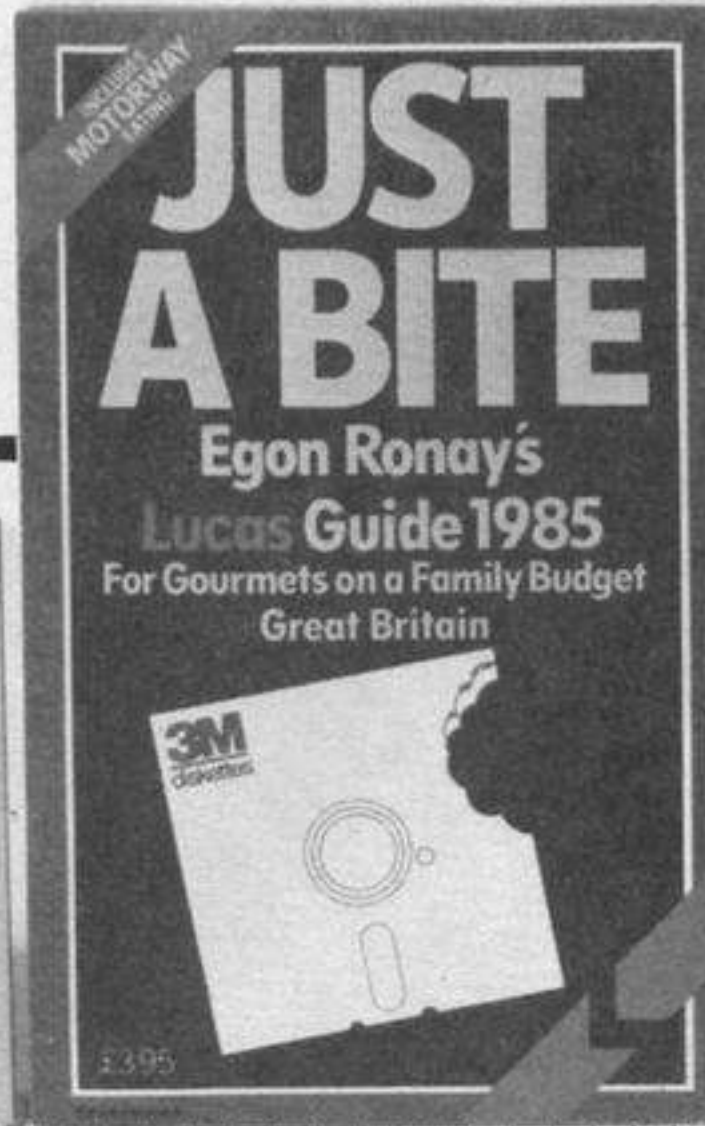

More MSX users

User groups and clubs magazines seem to be the growth areas of the home computer scene this summer and news has just reached us of a new club for MSX users.

Lee Simpson has started "The MSX Club" and offers a whole series of services to its members including newsletters, membership kits, games tips, competitions, news and many others.

The membership fee is £3 per year and this includes the regular magazine mailing. Further details can be obtained from Lee at the address given below.

Also on the MSX scene we hear that MSX User the monthly magazine published by Argus Specialist Publications will cease to be published with the October issue. We hope that MSX users who used to contribute programs and letters to the magazine will consider sending them to HCW as we do like to offer MSX content from time to time.

MSX Club, Lee Simpson, 3 May Fair Place, Tuxford, Newark, Notts NG22 0JD

Jungle Drums

Those feline peripheral manufacturers at Cheetah have just released their SpecDrum synthesiser for the Spectrum — what a surprise!

The simple plug-in unit costs just £29.95 yet claims to be able to produce sounds that are available in very expensive specialised drum machines. There is a software cassette which provides the user with eight different drum sounds from Snare to Hi-Hat but there is the facility to add other voices using optional software tapes.

The unit will only be available from your local Boots computer department, and they will also be stocking the voice tapes at £2.99 each. Do not despair however there will be two voices provided free when you buy your unit.

The system has a simple connection to your local hi-fi, ghetto-blastor or personal stereo so you can record or listen to the system without using the Spectrum's, beepfully bad, internal buzzer.

Cheetah, 1 Willowbrook Sci Park, Crickhowell Rd, St Mellons, Cardiff

A cymbal of affluence



Not so much a few releases more a mass escape as the software houses unleash a tidal wave of new titles at the PCW show

RELEASES

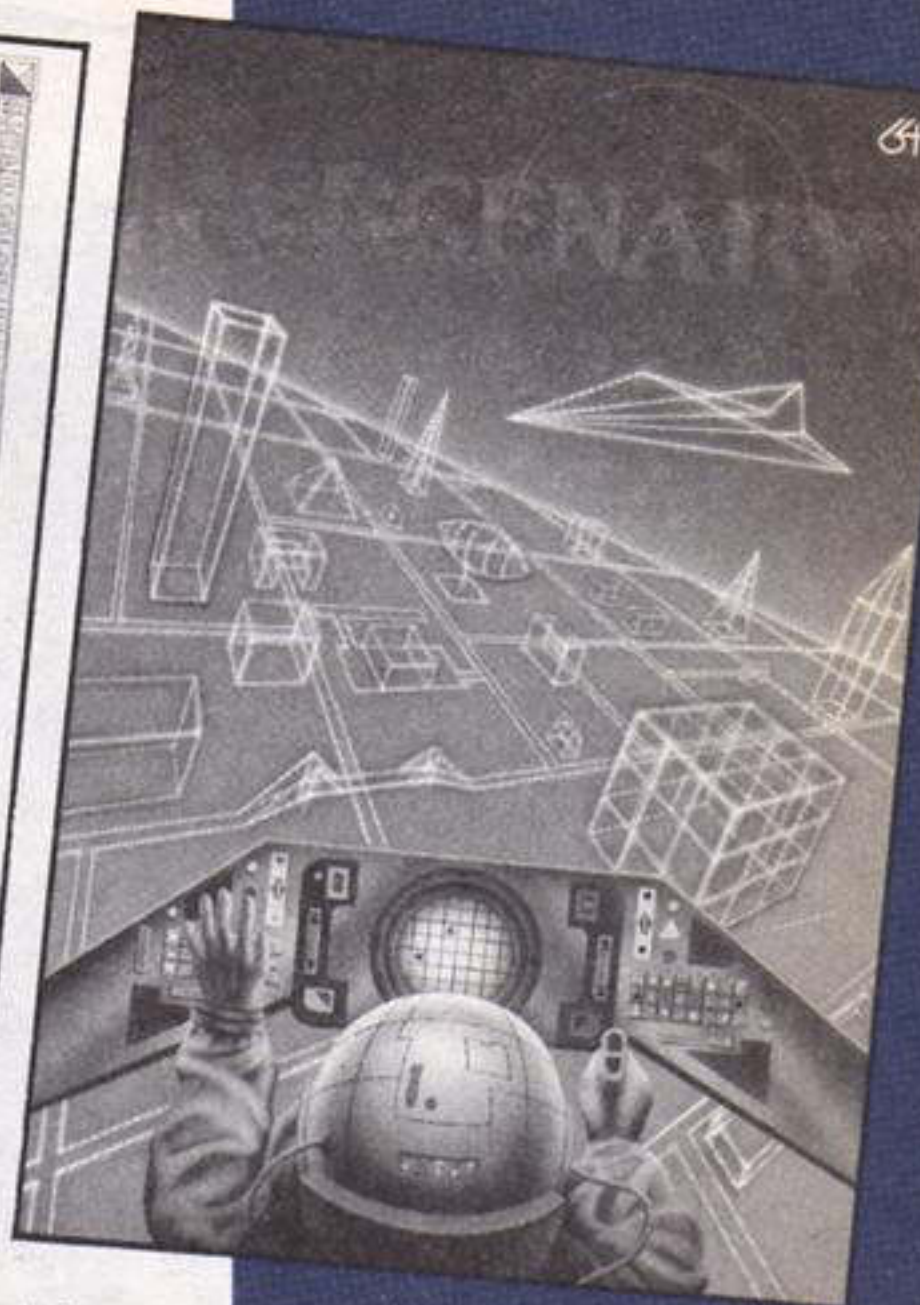

Olympia was turned into a vast launch-pad for software and amid the hyperbole that forms such an important part of launch-manship it was difficult to tell the potential high flyers from the nose divers.

have something to launch and, in keeping with tradition, many games promised for the show were in varying stages of unreadiness. The answer here for the experienced software house is to rapidly delaunch the game and herald it triumphantly as a preview.

So here is the alphabetical lowdown on the software show-down at PCW.

- Activision, not content with unveiling their new range of games also took the wraps off their newly spawned software offshoot, Electric Dreams. The independent label had their first three releases up for public ogling and the stand-out was **I, Of the Mask**, by Sandy White, author of Ant Attack. Highly surreal, featuring much flying through the eyes of an Easter Island style statue and using 3D graphics, **I, Of the Mask** will be released in October for the Spectrum, price £9.95.

Also available in October for the Spectrum is **Winter Sports**, a simulation of nine events — price £9.95. The first Electric Dreams product to become available will be **Riddler's Den**, an arcade strategy game due for release in late September.

- Of Activision's new releases the eye catching **Ballblazer** was attracting a lot of attention and

the high-speed futuristic game should be available for a wide range of machines in November.

- **Hacker**, an intriguing program that sets you the task of finding what on earth you have got yourself into when confronted by the words "Logon please" seems bound to appeal to the repressed hacker. This "what system have I stumbled into game," should be available for C64, Spectrum and Amstrad at the end of September.

- The scenario of **Little Computer People Research Project** casts you as a micro-anthropologist studying the domesticated humans who have made their home inside your computer. With his tongue thrust into his cheek, Gregg Fischbach, Activision President said, "We are marketing this as a piece of important research." Watch out around the beginning of December for **The Eiderlon** and **Koronis Rift** two further games from the Lucasfilms stable that produced **Rescue on Fractalus** and **Ballblazer**.

- Not to be outdone Alligata were also showcasing a protege company, the budget label Budgie. New games from Alligata itself included **Show Jumping** for the C64 and Spectrum, **Alkahera**, a 3D space simulation for the Amstrad, **Shoot Em Up**, blasting away imminently on the C64 and Atari and **Quiz Quest** with a 1000 question quiz on a multitude of topics for the Spectrum, Amstrad and BBC.

- Adventure International

were publicising a new graphic adventure called **Seas of Blood**, said to feature a new combat system.

- Anirog's new catalogue includes **Trivia UK**, the computer version of the board game Trivial Pursuits available for the C64 and Amstrad.

- Argus Press Software launched eight new games with titles from Quicksilver, Mind Games and Lothlorien. Mind Games, **Evil Crown** is a medieval power struggle in which the player has to expand the borders of his kingdom, keep down the serfs, amass a fortune and prove himself a dab hand at jousting. The icon driven game retails at £9.99 for the C64 and Spectrum.

- **Arena**, Lothlorien's latest combat simulation set on a futuristic battleground, the game which incorporates vector graphics in the tank battle sequences is available for C64, Spectrum and Amstrad at the end of September price £9.95.

- Audiogenic known up to now as Commodore specialists are diversifying. On show was the new Spectrum version of **Graham Gooch's Test Cricket** as well as games for Amstrad, BBC, Electron and Spectrum from Icon software of **Bugeyes** and **Contraption** fame.

- One company determined not to be missed was Ariolasoft who had rigged up a wall of 36 video screens to display extracts from their 15 imminent releases and preview tasters of a whole host of games scheduled for release later in Autumn. Featured heavily was **Skyfox**, Ariola-

soft's bestseller, now available on cassette for the C64.

- Among the September releases is **Three Days in Carpathia**, produced by the American company Ram Jam Corporation. This "infuriatingly complex" adventure with a humorous touch is available for the Spectrum and C64, £11.95 and on C64 disc for £14.95.

- Scheduled for release in the next couple of months are **Archon II** and **Think! Archon II**, subtitled *Adept*, is a game blending strategy and arcade elements in an Apocalyptic vein. Magicians and monsters roam over a variety of battle-grounds, representing Earth, Water, Air and Fire. **Archon II** will be available for the C64 £9.95 (£12.95 disc) and the Amstrad £8.95.

Think! — a game to get you cogitating — is described as being "easy to learn but difficult to master" and for the advanced brainbox there are additional games **Blitz Think!** and **Speed Think!** If you are thinking about the cost, cassettes for the C64, Atari and Amstrad cost £8.95 and the Spectrum version will retail at £7.95.

- Beyond who will shortly be releasing **Superman**, the computer game for Spectrum, C64, Atari and Amstrad, under the First Star banner, price £9.95.

Beyond claim the game will be the first to be released throughout the world in the same week. Two sequels were also unveiled by Beyond. **Enigmaforce**, the follow-up to **Shadowfire**, for the Spectrum and Commodore, price £9.95 and **Spy vs Spy: The Island Caper** following up **Spy vs Spy**. **The Island Caper** will cost £9.95 and be available for the C64. All three games are set for release sometime in October.

- The British Educational Software Association (BESA) was officially launched at PCW. The consortium of Edsoft companies including ASK, Bourne Educational Software, Calpac, Collins, Griffin, Hill MacGibbon and Widgit was formed to increase the availability of educational software through retail outlets and promote public awareness of the benefits of educational software.

- Bubble Bus were showing **Star Quake** for the first time, the game which features over 500 locations and is positively galactic in scope will be available on October 15th for the Spectrum price £7.95.

- CDS were featuring multiple versions of **Steve Davis' Snooker** including the new C64 version and promoting its sister budget company Blue Ribbon, the first pocket money range for the BBC and the Electron.

- Chess specialists CP Software introduced **3-D Voice Chess** for the Amstrad which features software generated speech output and 3-D graphics. In the next few weeks CP will be releasing **3-D Superchess 4.00** and **Supercode** for the Amstrad.

- **Bladerunner** — a forthcoming game from CRL — was on show for the first time along with the Amstrad version of the racing game **Formula One**.

- Domark had **Codename Mat II** making its debut at their stand. The space adventure subtitled *Alien Termination* (need we say more?) is available on Spectrum, C64 and Amstrad (£8.95) with disc versions for the Amstrad and C64 to follow.

- Among the hundred or so titles confidently predicted to be a surefire No 1 at Christmas by its makers was **Fairlight** from The Edge. The 3D graphic adventure is available on the Spectrum.

- Gaming for Enterprise owners took a leap forward as 35 new titles were announced for the machine. A selection of leading titles include, **Wizards Lair**, **Beach Head**, **Mordens Quest**, **Lands of Havoc**, **Nodes of Yesod**, **Dr Strangeloop** and **Sorcery**. One of the new releases the **Seventh Seal** is the first to be specifically written for the Enterprise 128.

- Global Software weren't at

PCW but chose to launch their new game **Old Scores**, erroneously called *South Bank* in last weeks HCW — during its duration in the less frenzied atmosphere of the Thameside Festival Pier. **Old Scores**, a crime adventure using locations on London's South Bank will be available for the Spectrum £6.95 and C64 and Amstrad £7.95. Also on show was a finished version of Global's **The Magician's Ball**.

- Firebird were previewing their Spectrum version of **Elite** now in the final stages of conversion — the game will cost £14.95. Also available shortly will be an Amstrad version of the cult game for £14.95 and £17.95 (disc).

The C64 conversion of **Sabrewulf** (£9.95) should be available in the next fortnight according to a Firebird spokesman.

It was also revealed that Firebird intend to drop the price of their Silver Range from £2.50 to £1.99 effective from October 1st. Coming soon on the Silver label are three titles, **Spike**, **Caverns of Eriban** and **Super Rider**. Meanwhile on the new Super Silver label, Firebird were showing **Thunderbirds** and **Willow Pattern** (shouldn't it be on the bone china label?) compatible with Amstrad, Spectrum and C64. The price of

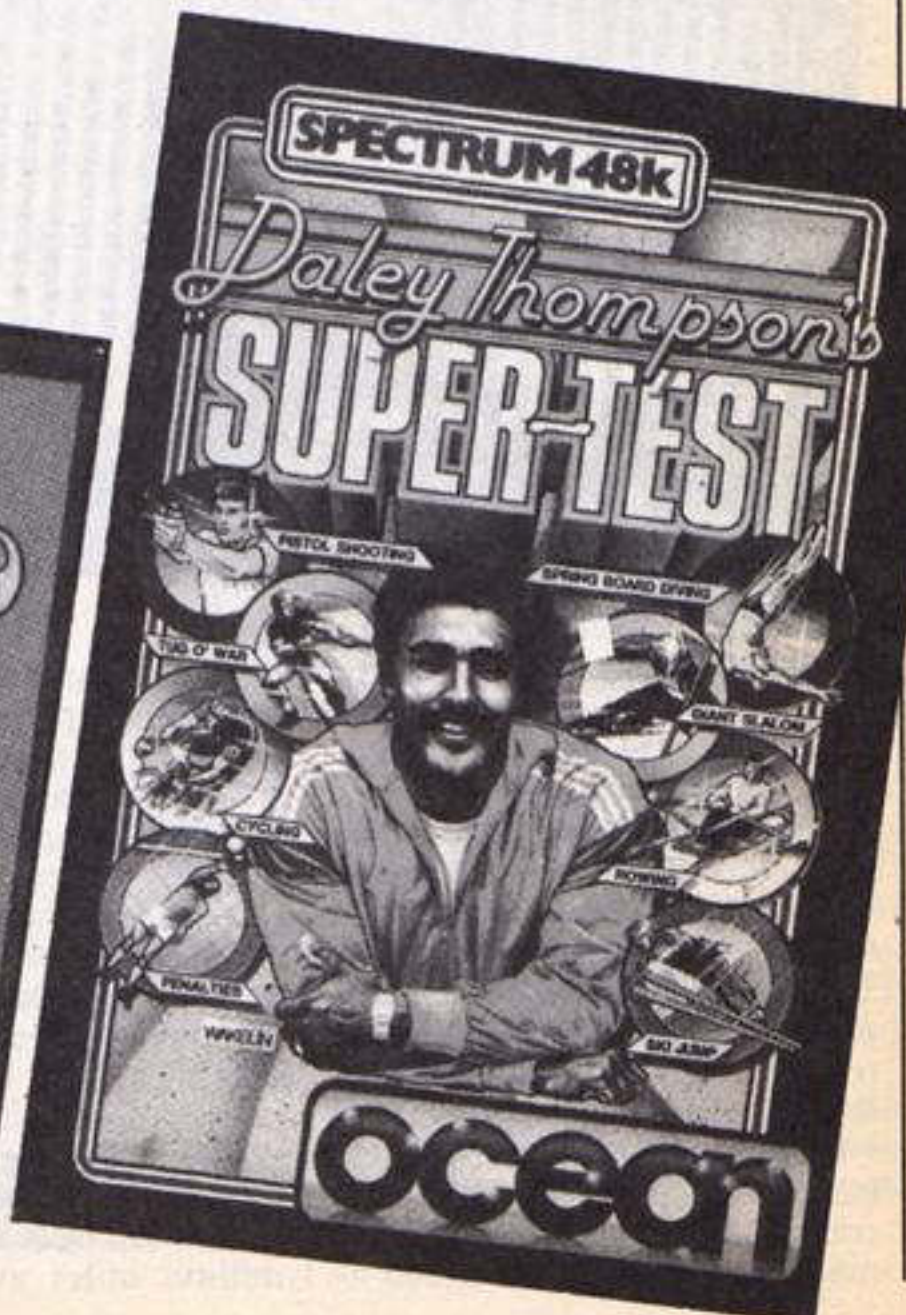

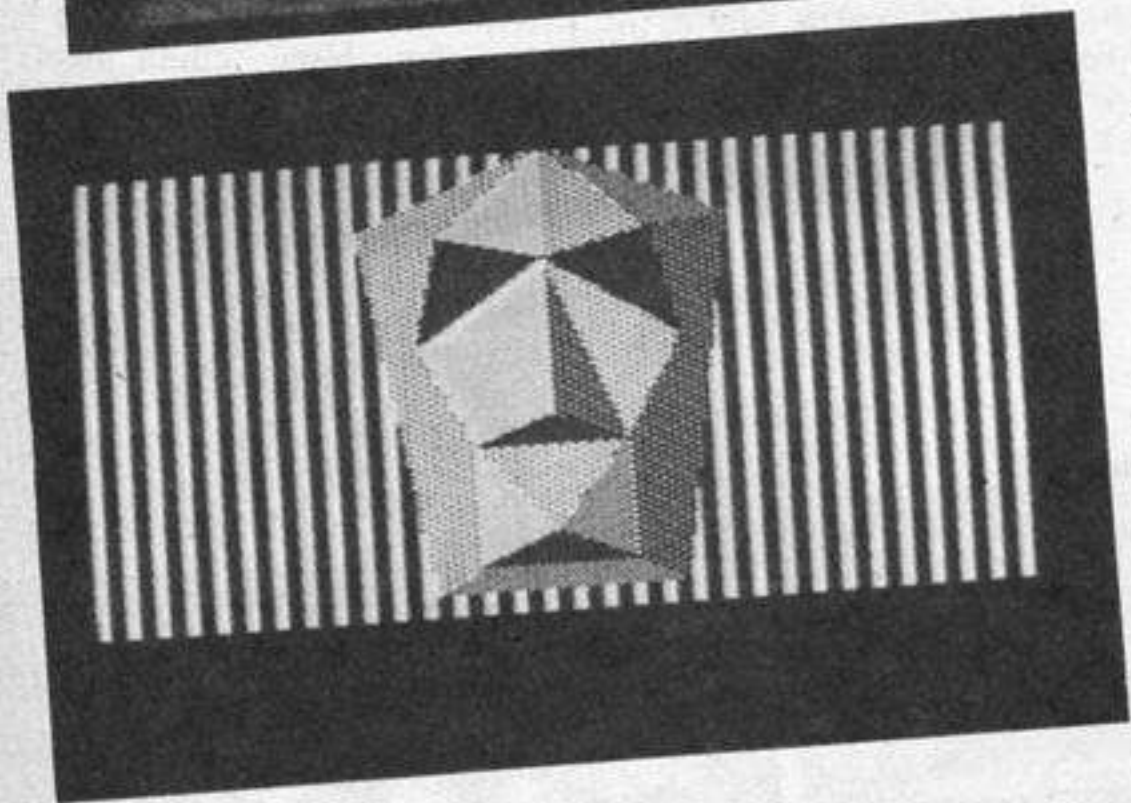

the Super Silver range is still to be announced.

- Interceptor Micro's were showing off **Warlord**, their new graphical adventure for the Amstrad. The Celts versus Romans game costs £8.95.

- Level Nine were previewing **The Worm in Paradise** the final part of the Silicon Dream trilogy following **Snowball** and **Return to Eden**.

- **Batalyx** is Llamsoft's latest game. Written by Jeff Minter it comprises of six sub games making up what is described as

an "integrated suite". For the C64, **Batalyx** costs £9.95. A compilation entitled **Yak's Progress** featuring eight Jeff Minter games ranging from **Gridrunner** to **Ancipital** will be available in the near future.

- Martech were showing three programs about the universe and the strange life forms that inhabit it. **The Planets** is based on the forthcoming TV series about our neighbours in the solar system. Martech's **Zoids** — The Battle is set on a planet a million miles away where the

mechanical monsters fight it out to the death. **Zoids** costs £7.95 on cassette for the Spectrum and £8.95 for other leading machines.

Geoff Capes, of course is a life form peculiar to earth and he was at the show to publicise the **Strongman Challenge** game he has endorsed. Available in October, for a wide range of machines it costs £7.95-£8.95.

- The Mastertronic Stand was attracting hordes of gamers wanting to sign on the dotted line to join the new **Tronix** club. Colin Johnson of Mastertronic estimates there are now over 2000 members.

- Melbourne House were presenting the first public

showing of **Lord of the Rings** the follow up to the **Hobbit**. **Lord of the Rings** will be available for the C64, Spectrum, Amstrad and BBC. Coming some time before Christmas is the game tipped by Melbourne to emulate the success of the **Way of The Exploding Fist**.

- **Fighting Warrior**, for the Spectrum and C64 will be a quest arcade game set in Ancient Egypt. The hero has to save the beautiful princess from being buried alive and fight his way through the passages of the sacred pyramid to get to the inner sanctum and face the pyramids fiercest



NEW

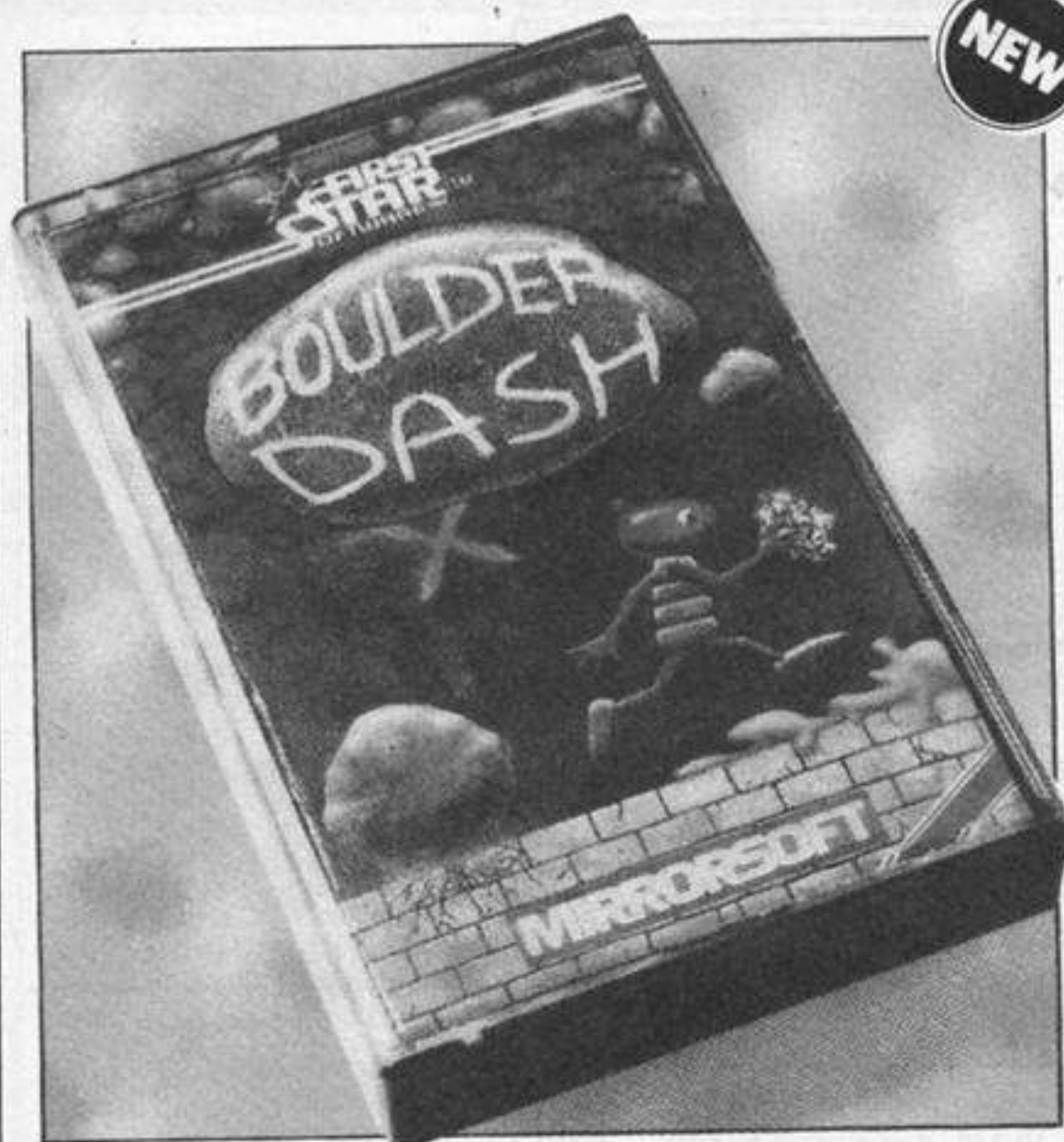

protector. Judging by the combat sequences previewed at PCW, the game will be of great appeal to those suffering from joystick cramp playing Exploding Fist.

Melbourne House has also announced that it has secured the rights to the cartoon hero Asteryx and the moustachioed hero will be appearing on Spectrum and C64 in the run up to Christmas.

• Mirrorsoft were hot on TV connections with their stand being visited by Blue Peter and Video and Chips and their **First Steps with the Mr Men** personified by cuddly replicas of the same. One of their most instructive contributions to the market

Fleet Street Editor was on show — demonstrating how you can produce your own newspapers and newsletters. The Mr Men range looked a lot of fun with colour and co-ordination playing a major part of both games.

The good news for Amstrad and Atari arcade fanatics was that **Boulder Dash** is now available for their machines and can plan strategically to their hearts content.

• Ocean certainly seemed to be enamoured of the macho male with **Daley Thompson's Supertest** for the Spectrum just released, at £6.95 and previews of their Christmas games **Rambo First Blood Part II**, **Street Hawk**, **Knight Rider** and "V" all echoing the sentiment of survival of the fittest.

Continuing the trend of licensing, established by Frankie goes to Hollywood's rock bonanza, Ocean's **The Neverending Story** for the CBM 64 at £9.95 will be released later in September.

• Unfortunately one of the expected highlights of the show, the Mikro-Gen Plus was not ready for public view. The new interface that expands the Spectrums memory by almost 50 per cent is expected to be ready very shortly. The first game to feature the Mikro Gen Plus will be the multi role fantasy adventure **Shadow of the Unicorn**, which complete with a book will retail at £14.95.

• Novagen were featuring their new epic space adventure **Mercenary** scheduled for release just after PCW. Initially available for the C64 and Atari (£9.95 and £12.95 for the disc version) Spectrum and Amstrad versions are expected in November.

• Orpheus were previewing the **Young Ones** game and showing the finished version of **Tujad** available now for the Spectrum price £8.95.

• US Gold proved to be one of the premier attractions for gamers. Previewing were **The Goonies** based on Steven Spielberg's latest film. Their two mega follow ups **Summer Games II** and **Beach Head II** were also attracting avid attention. US Gold were emphasising their support of the Atari with over 30 titles in their range, for the machine.

Other games on the way from US Gold include some well known names such as **Donald Duck**, **Kermit** and **Zorro**.



TEXT EFFECTS

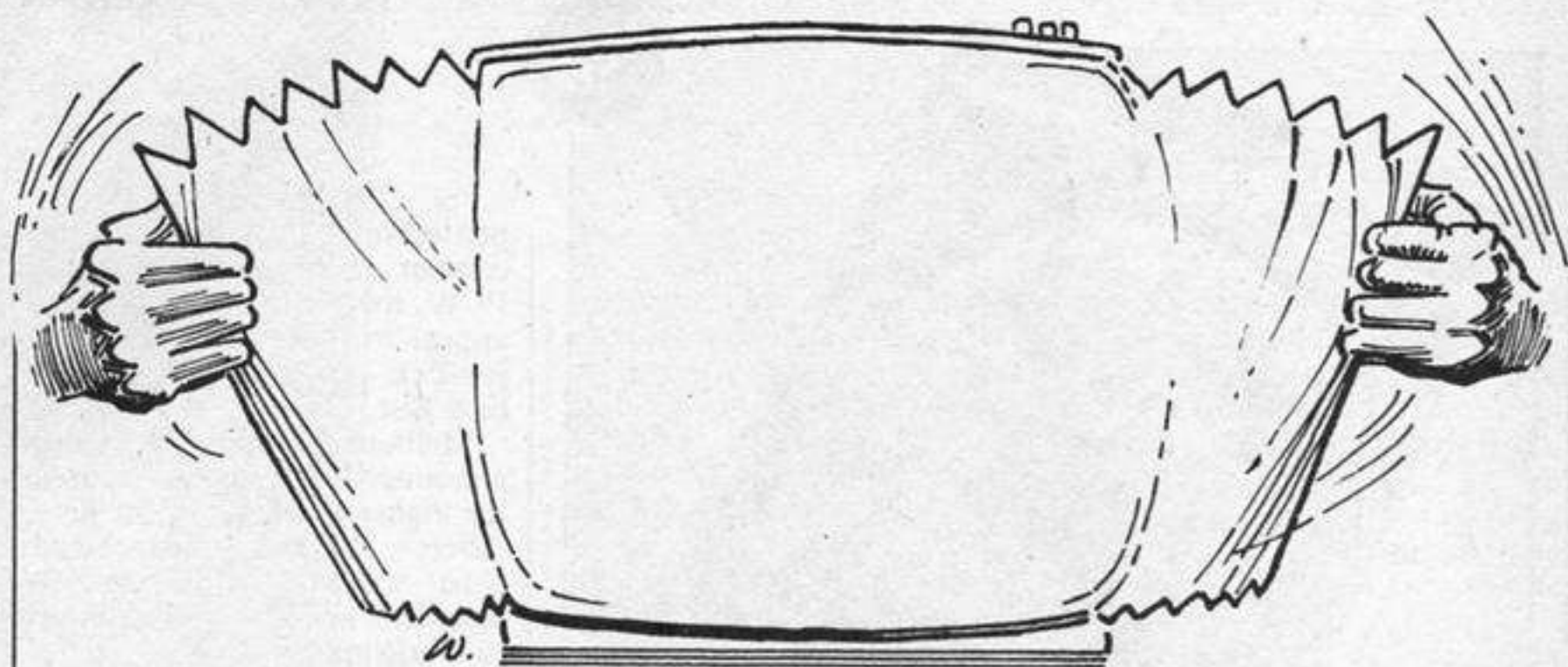

If you thought your Spectrum was forever confined to 32 x 24 lines, think again. Neil Christie's program gives you those extra columns

This small but beautiful utility for the Spectrum enables you to achieve a 29 x 64 line text. Some said it couldn't be done. Find out for yourself with a listing that expands the choice of text for your Spectrum.

How it works

10-140 demonstration lines
9000-9300 main loop
9900-9994 stored data for characters

Variables

z\$ character array
x x co-ordinate
y y co-ordinate
xx,yy draw length
x\$ one letter or number of z\$(n)
C,F loop variables

```

0>REM *** 29 by 64 TEXT *** VARIABLES:z$=Character string      x=x c
o-ordinate      y =y co-ordinate      All remaining variables are used
for loops,etc.
10 LET z$="HOW WOULD YOU LIKE 29 * 64 TEXT (1856 CHARACTERS) ??": LET X=12: L
ET Y=170: GO SUB 9000
20 LET Z$="YOU WOULD .. WELL WATCH THIS FOR A DEMONSTRATION AND BE AMAZED": LE
T X=2: LET Y=Y-6: GO SUB 9000
30 BEEP .1,23: BEEP .1,34: LET Z$="THIS BASIC UTILITY WILL ENABLE YOU TO HAVE
29 ROWS BY 64 COLUMNS": LET X=0: LET Y=Y-6: GO SUB 9000
40 LET Z$="IT WILL ALLOW A MAXIMUM OF 1856 CHARACTERS PRINTED ON THE SCREEN AT
ONE TIME COMPARED WITH THE NORMAL 704 CHARACTERS USUALLY PRINTABLE AT ONE TI
ME.": LET X=0: LET Y=Y-6: GO SUB 9000
50 LET Z$="THIS PROGRAM CAN BE USED FOR A WORD PROCESSOR, ADDING EXTRA TOU
CH TO YOUR TITLE PAGES, OR FOR JUST THE USE OF PRINTING TEXT"
60 LET X=0: LET Y=Y-10: GO SUB 9000
70 LET Z$="THE CHARACTERS YOU CAN USE ARE AS FOLLOWS ": LET X=5: LET Y=Y-10:
GO SUB 9000
80 LET Z$=" !\"#$%&'()*+,-./0123456789:;<=>?@ABCDEFGHIJKLMNPOQRSTUVWXYZ[\]^_`{|}
~": LET X=X+4: GO SUB 9000
90 LET Z$="NOW LET'S COMPARE IT WITH NORMAL TEXT": LET X=43: LET Y=Y-7: GO SUB
9000
100 PRINT AT 10,0:Z$
110 LET THIS PROGRAM IS COPYRIGHT OF NEIL CHRISTIE JUNE 1": LE
T X=4: LET Y=1
120 LET Z$="XXXXXXXXXXXXXXXXXXXXXXXXXXXXXXXXXXXXXXXXXXXXXXXXXXXXXXXXXXXXXXXXX
XXXXXXXXXXXXXXXXXXXXXXXXXXXXXXXXXXXXXXXXXXXXXXXXXXXXXXXXXXXXXXXXXXXXXXXXXXXX":
PRESS ANY KEY %
LET X=56: LET Y=20: GO SUB 9000
130 PUSE 0: LET Z$="!! REMEMBER !! DON'T USE LINES 9000 ONWARDS IN YOUR BASIC
PROGRAM OR YOU WILL WIPE-OUT THIS UTILITY": LET X=0: LET Y=170: GO SUB 9000
140 PAUSE 0
8888 STOP
8999 REM >> MAIN LOOP <<<
9000 FOR C=1 TO LEN Z$:
9002 IF X>252 THEN LET X=0: LET Y=Y-6
9004 IF X<0 THEN LET X=0: LET X=169
9010 INVERSE 1: FOR Z=0 TO 3: PLOT Z+X,Y: DRAW 0,5: NEXT Z: INVERSE 0
9012 IF X>255 THEN LET X=0: LET Y=Y-6
9014 IF X<0 THEN LET X=0: LET X=169
9020 LET X$=Z$(C): IF X$=" " OR X$="@" OR X$="$" OR X$="%" OR X$="Y" THEN LET X
=X+4: NEXT C
9025 IF X$("<" OR X$(">" THEN LET X=X+4: NEXT C
9027 IF X$("<" AND X$(">" THEN LET X=X+4: NEXT C
9030 IF X$="!" OR X$="'" OR X$=":" OR X$="." OR X$="," OR X$=";" THEN PLOT X+1,
Y
9032 IF X$="!" THEN PLOT X+1,Y+3
9034 IF X$="%" THEN PLOT X,Y+4: PLOT X+2,Y
9036 IF X$="@" THEN PLOT X,Y: DRAW 2,0
9040 IF X>255 THEN LET X=0: LET Y=Y-6
9050 IF X<0 THEN LET X=0: LET X=169
9060 RESTORE (CODE X$+9867)
9070 READ Y$: LET X$=CODE Y$(1): LET Y$=CODE Y$(2)
    
```



```

9090 LET xx=xx-48: LET yy=yy-48
9090 PLOT x+xx,y+yy
9100 FOR f=3 TO LEN v$ STEP 2
9110 LET xx=CODE v$(f): LET yy=CODE v$(f+1): LET xx=xx-48: LET yy=yy-48
9120 DRAW xx,yy
9130 NEXT f: LET f=f+4: NEXT f
9140 RETURN
9900 DATA "1202"
9901 DATA "021102/00/"
9902 DATA "1004//20..20"
9904 DATA "00012201"
9906 DATA "14"
9907 DATA "20/10211"
9908 DATA "001102/1"
9909 DATA "0022//12."
9910 DATA "1002//20"
9911 DATA "10"
9912 DATA "0120"
9913 DATA "10"
9914 DATA "00012201"
9915 DATA "12/00/1/1102/1//"
9916 DATA "0020/004//"
9917 DATA "04101/..0/20"
9918 DATA "001011/11101.0"
9919 DATA "20020/.003"
9920 DATA "001011/1/00220"
9921 DATA "14//0.1/11/1"
9922 DATA "10011102.0"
9923 DATA "1011.2111/.."
9924 DATA "101102/1//1/"
9925 DATA "12"
9926 DATA "12"
9927 DATA "10/111"
9928 DATA "0220"
9929 DATA "1011/1"
9930 DATA "121101.0"
9932 DATA "0003111/0-71"
9933 DATA "0004101//1//1/"
9934 DATA "21//102111/"
9935 DATA "0004101/0.//1"
9936 DATA "20.00210/00220"
9937 DATA "000210/00220"
9938 DATA "220//10211"
9939 DATA "00040.20020."
9940 DATA "0020/004/020"
9941 DATA "011/1103"
9942 DATA "00040.1011010//1/0/"
9943 DATA "20.004"
9944 DATA "00041/0/100.04"
9945 DATA "00041/0.1/04"
9946 DATA "101102/1//0."
9947 DATA "0004101//1"
9948 DATA "101102/1//0.101/"
9949 DATA "0004101//1/0/"
9950 DATA "001011.21110"
9951 DATA "1004/020"
9952 DATA "040-1/1004"
9953 DATA "040-1/1103"
9954 DATA "00040.100/1/04"
9955 DATA "000122010//1010/2.0/"
9956 DATA "040.1/0/011102"
9957 DATA "04200//0/20"
9958 DATA "10/00410"
9959 DATA "2001.201"
9960 DATA "001004/0"
9961 DATA "03111/"
9962 DATA "0030"
9963 DATA "20.00210/00111"
9990 DATA "20.2100111"
9991 DATA "1004"
9992 DATA "0022/001/1"
9994 DATA "21.00220"
    
```



GO

MONTY ON THE RUN

Super fit and desperate for freedom. Monty makes his daring escape from Scudmore Prison. With the help of the criminal underworld he must collect the five correct elements of his freedom kit including the gold coins that will make him a mole of leisure.

At last he's free but can he make the cross-channel ferry

GO STRAIGHT ROUND TO YOUR SOFTWARE DEALER - MONTY ON THE RUN

ON SALE OCTOBER 8TH - THE RACE IS ON TO GET YOURS BEFORE THEY ALL GO!!!

Gremlin Graphics Alpha House, 10 Carver Street, Sheffield S1 4FS. Tel: (0742) 753423.



VENTURES

After a brief release for me to go on holiday and some sunshine, I'm back here, in the dark, damp dungeon at the bottom of the hideously evil Argus Press Towers. This week I will be concentrating mainly on your adventure problems, along with a few short reviews. But first, the good news.

Adventure International are currently converting the entire range of Scott Adams adventures for the popular home micros. At the moment AI only sell Atari and Acorn versions, but soon Spectrum, Amstrad and CBM owners will be able to pit their wits against the most devious of puzzles. It will be a little while yet however; it's no small task, since the AI team have to add new graphics as well, and new releases such as Robin of Sherwood naturally take precedence.

Back to the present. Phineas Frogg is an "educational" adventure from Mirrorsoft, written by Widge. I'm often a bit dubious of such games because they can be really tacky, just simple adventures with the educational value coming from "mapping skills". Phineas Frogg is anything but, being both fun and useful, although it bears a rather close relationship to Creative Sparks educational Danger Mouse adventure.

The frog of the title is a secret agent, and his task is to rescue Professor Mole from SLOTH, which stands for the Secret Lair Of The Terrible Hamsters. An excellent manual is included which sets the scene in tongue-in-cheek style, and a useful hint sheet is enclosed in an envelope marked "Top Secret". A good idea for children who may be inexperienced with the type of thinking required for adventures.

The player moves around the locations, which are all well described and each have a good illustrating graphic, by choosing options from a numbered menu. Often there is animation of Phineas hopping from place to place. The adventure will demand quite a lot of deduction from the player, although the fact that the possible options are presented obviously makes things easier.

As well as the adventure there are mini-arcade and strategy games built in, like a Frogger



After a few days in the sun Peter Sweasey and his diminutive helper are back in the dungeon and hard at work, keep sending them your pleas for help and offers of lifelines

variant, a car driving game and a block sliding puzzle. All of these are well programmed, with smooth moving graphics. One feature I particularly liked is the way that the time taken for the player to reach a strategy game affects its difficulty. Thus bright players are still presented with a challenge.

One major quibble is that nowhere on the packaging is a recommended age range given, and the fact that this is aimed at children is hardly mentioned. I also think that an inventory key should have been added, because sometimes the child can lose track of what is being carried. Overall, a good buy for under eleven.

I recently found some budget games called Double Play Adventures in my local software shop. Two games for £1.99 cannot be a total rip-off I thought, so I bought one. Number seven, of about ten,

contains The Hexagonal Museum, which has you trying to steal the Star of India gem from a museum, like in the opening of a Pink Panther film; and A Tangled Tale, which is a fantasy adventure based on the writings of Lewis Carroll, and involves solving codes and a lot of lateral thinking. It came as no surprise to me that they are written with version A Quill, and fall into many of the traps I've previously outlined about Quill games.

However, for only a pound each, some adventurers may be satisfied, particularly with A Tangled Tale. If I manage to track down the manufacturers I'll review the whole series; or perhaps some HCW readers have bought some, and can send in their comments. If you have, write to the address at the end of Ventures.

A quick reminder, however, that the best Budget adventures are the superb Games Without

Frontiers series from 8th Day. If you have £1.75 to spend I strongly urge you to buy Faerie of Quann Tulla. You won't be disappointed!

Phineas Frogg

Price: £7.95

Publisher: Mirrorsoft

Address: Holborn Circus, London EC1P 1DQ

SPECTRUM



Double Play Adventure

Price: £1.99

Publisher: Double Play Adventure

Address: Available from software stockists

SPECTRUM



Games Without Frontiers

Price: £1.75

Publisher: 8th Day

Address: 18 Flaxhill, Moreton, Wirral L46 7UH

SPECTRUM



Helpline

A brand new section to the helpline later, but first some more reader questions. An adventurer called Yui writes from Poole in Dorset about Adventure International's ever popular Hulk. He wants to know how to lift the ring, and escape from the underground room. Similar solutions both times actually. You need to REMEMBER NIGHTMARE in certain areas. This makes you super strong for a few moves. Pulling the ring will partly answer the second part; scratch about a bit too, and eat raw egg to stop yourself being blown up.

John Wilson noticed a mistake in some Heroes Of Karn hints I gave a little while

back — probably a gremlin from the following paragraph, he suggests. Anyway, you need the dagger to kill the pirate, not the bottle. John also gives some tips for the popular arcventure Tir Na Nog. One of the quest objects is Dagda's Cauldron, which is located in Ceardach Calum. Enter through a back door of the Slige Warrens, using a Daisy. To pass the cave wights, carry a gem of the same colour as the cave, and to leave the library, become an art lover! And if, like me, you really hate those sidhe, POKE 34202, 0, on the Spectrum version. We'll have some slightly more up to date hints for Dun Darach in a coming issue.

N G Marshall needs help in Interceptor's little known Token Of Ghall. In fact, I had to phone Julian Jones at Interceptor about this one, because I had never heard of it. Still, you need to take the sword from the princess in the castle, then, providing you have enough energy, you can kill the spiders in the cave.

Now the new section I promised. It is — fanfare please — Maze Corner (massive cheer from millions of people). I have never liked mazes; they don't test ability, they just slow down the player, frustrate him or her, or totally stop the player's progress. If you agree, then keep an eye on Ventures, because every column from now on we will be guiding you through some of the most famous and most difficult mazes.

The most obvious game to start with is Colossal Adventure. To find the vending machine in the maze of twisty tunnels, all different, go S, CLIMB E, E, and then to return go N then UP. To find the sandwiches, go S three times, then North back to the small building.

Freddie Still from London E1 cannot find the bayonet in Colditz. You need to make it, using a dagger and rifle. To find the dagger, go, from the castle sewer: E, N, E, W, E, then to return go WEST. You will need to sharpen it.

Finally in Maze Corner this time, help with Mikro-Gen's brilliant Witch's Cauldron, from Ventures regular John Rundle. From the workshop: OPEN DOOR, S, S, E, E, S, W, W, S, E, N, where you will find

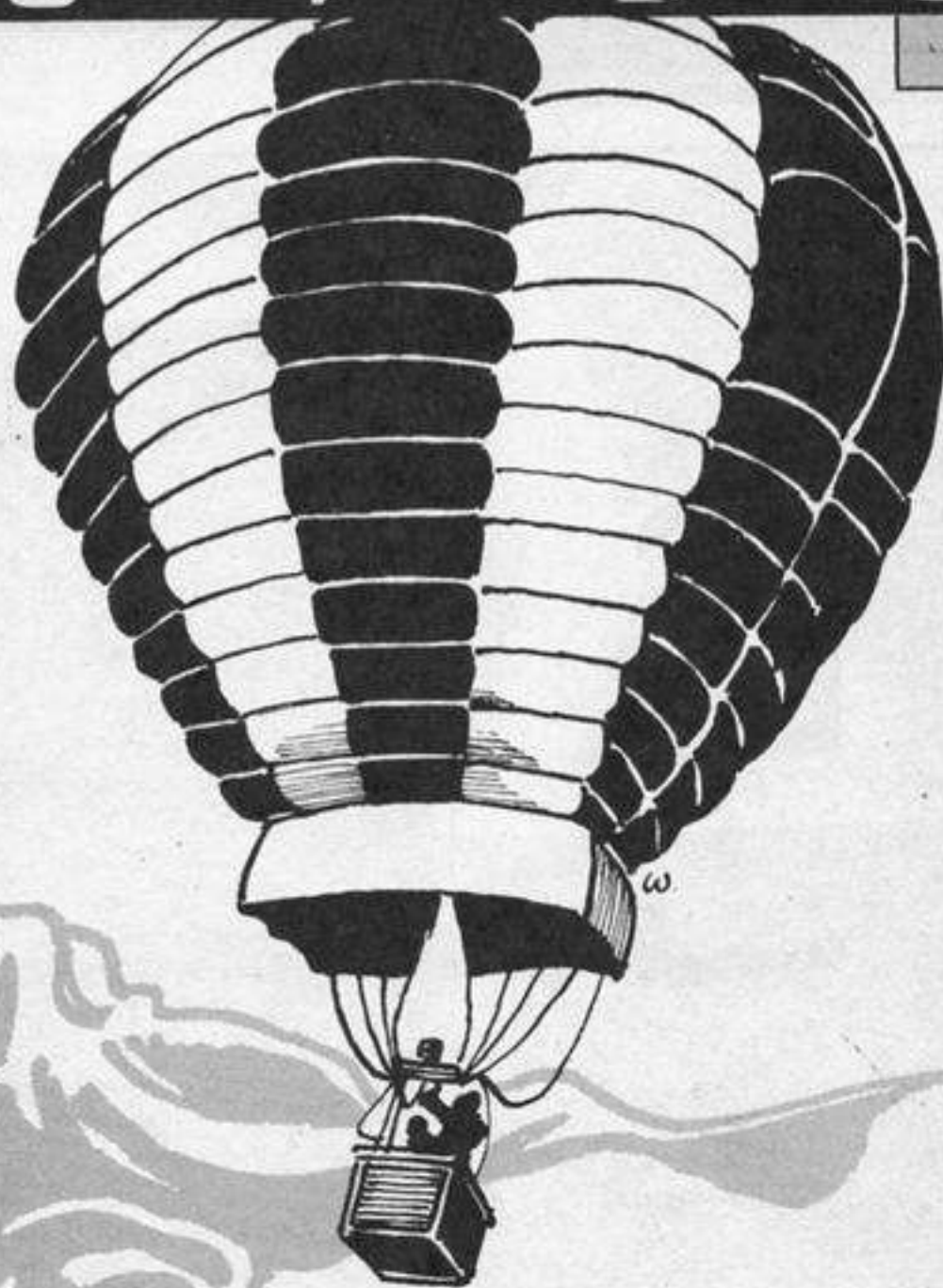

the large key, then W, N, E, N, to the East door. Mapping that lot must have been fun! John adds that he would recommend Witch's Cauldron to anyone, saying that it is "interesting with good and fast graphics". I agree, so here are some more hints. In the mouse trap, ask for what you want. The devil's number is triple six, and the assistant's name is right in front of you. Ignore the soot, but look in, under and on top of; examine everything, and use HELP frequently. Crush the snails shells with the pestle. Remember: you are not human, so you can go to unusual places. More hints soon.

A little cheat here for anyone who bought The Sandman Cometh by Star Dreams. If you haven't solved Part one yet, never mind, just load side two. When it asks for a ticket number, press STOP. Then, type GOTO 1100, LOOK to start the adventure proper — or you could look through the listing. The competition sounded interesting — spot the names of software companies!

Texas owner Mark McGurn is having problems with Savage Island 1. The knife and block at the bottom of the lake can be swam down to — but don't forget to hold your breath! Once you have the block, take it through something and there will be light!

I have a request for help with Zim Zala Bim. Can anyone tell Peter Harrison how to get into the palace? Sadly, I never managed to get hold of this one. Simon Pick from Cornwall

cannot find the micro-battery in Artic's Ship Of Doom. You need to wear the spectacles, if I remember rightly. In the same game, Bill White of Belfast cannot work out the button order — ask the computer for help with that!

Finally, a few quick hints for Runestone, originally from Games Workshop but now being published by Firebird. At the start of the game, take Morval to Loravel's fortress, once you have the sword, ask Lissa to give you help — and her coin. You can use this to buy ale and bread from Maladron the merchant later. Later on in the game, and the following bit is written backwards so it doesn't spoil the enjoyment of people who may read it accidentally, ssertrof s'rimodroK dnuora raef fo niatruc eht syortsed, snoinap-moc eerht eht fo eno yb nrow neh, gnir revlis eht. (Start reading backwards at the end of that sentence). More hints for this wonderful game next time.

That just about wraps it up for this time. Remember, I can help you with adventures by Artic, Level 9, Interceptor, Scott Adams and more. Try me. Whenever possible, I give a personal reply, although this sometimes takes a little time. Don't forget, I want to see your solutions and comments on adventures as well. Happy venturing!

Write to: Peter Sweasey, Ventures, Home Computing Weekly, No.1 Golden Square, London W1R 3AB.

RON COMPLEX



Ron Complex falls into the hands of the dreaded Logic Squad and faces a grilling in this all chills, all spills episode of our multi-million dollar budget serial

Ron felt Lieutenant Pythagoras's grip tighten on his shoulder and in turn he clamped his fist more firmly round the collar of the figure in black seated at the computer keyboard in front of him. "Okay lieutenant it's your move," said Ron. "Let's take a little walk," murmured the lieutenant.

Lieutenant Pythagoras yanked Ron backwards and the figure in black was pulled to his feet. "Take it nice and slowly," said the lieutenant. "You at the front, I want you to walk to the door and proceed to the lift."

As the three of them walked along the corridor still in a shoulder gripped mode, Ron felt the lead man getting decidedly twitchy. "I think he's going to make a run for it,"

said Ron. "Stay with him," said the voice behind him. The man in black took off at high speed and the trio careered along like a high speed conga-line buffeting into the walls as they went round a corner. "I could try tripping him," shouted Ron. "Do it," said the lieutenant.

Ron brought the man in black down with a crunching slide tackle and they collapsed in a writhing heap. The man in black was the first up. Ron saw him escaping down the corridor and noticed that he was wearing one brown brogue and a red slip-on sandal. "I'd know that footwear anywhere," thought Ron, "Well, well it's Dr Demento."

Lieutenant Pythagoras frog-marched Ron through the

building, as they passed by empty offices Ron saw that every monitor screen was lit up and text was filling the screens at an incredible rate.

"Could we just take a look at this before you grill me," asked Ron.

"Okay but make it snappy," said the lieutenant.

Ron stared at the screen, the message began, "This entire system has been fitted with a random code word generator at no expense to your company. The RCGW changes the entry word for your system once every few seconds giving you full and infallible protection from prying eyes and also from yourself."

"We do hope that the RCGW renders your system completely inoperable. Here are just a selection of the infinite number of codewords that you will never be able to use.... banana, giraffe, coldstream guard, dental floss...."

The list continued. "I've seen enough," said Ron, "I hope you've got in some extra light-bulbs just in case I don't crack too easy."

Ron sat in the interrogation room at Logic Squad headquarters, his eyes were slowly adjusting to the bright light that was shining straight into his face.

"Let's try it again Complex. What were you doing on the sixth floor of the Amalgamated Consolidated building?"

"That's some wattage your lamp is using up," said Ron "Your electricity bill must be a nightmare."

"Cut the cracks Complex. All right, if $x = 1$ and $y = 7$, what is z in the equation $4x - 12y x z = 37$?"

"I don't know."

"Inability to solve a simple algebra problem. That's six months in the Scrubs, Complex, under the Difficult Sums Law of 1991."

"What?"

"I'll ask you some easier ones if you tell me what you were doing and who you are working for."

"Can it Pythagoras, my memory is almost as bad as my maths."

The Lieutenant leant forward with his fist clenched. The bulb in the lamp went and the room went black. "Hey Complex," said a voice in the darkness, "you got a match?"

Next week: Grilled to a turn.

PERIPHERAL



Cliff Joseph discovers the benefits of slowing his Spectrum down using Nidd Valley's Slomo

There is, I believe, a battle currently going on between Nidd Valley Micro Products and Kempston Microelectronics over the right to produce and sell peripherals with a slow motion feature. So, we thought we'd have another look at the product that started the slow motion race, the Slomo unit from Nidd Valley.

The Slomo consists of an edge connector unit (with a through port in the rear to allow joystick interfaces etc. to be used simultaneously), from which a length of fairly heavy-duty wire extends, connecting it to a small hand held unit. On this hand unit are two buttons (on/off and freeze frame), a small L.E.D. indicating whether the Slomo is on or off, and a dial that controls the speed at which the Spectrum screen display is "refreshed".

It is this last feature that produces the slow motion effect and which allows you to slow down the action on all Spectrum programs (there are versions of the Slomo for a number of other machines, though certain programs on

some machines may be unaffected by it).

The most obvious use of the Slomo is just to slow down some of those frantic, panic inducing arcade games so that you don't get blasted to bits within seconds of loading them. Then, as you become used to playing the games at slow speeds you can increase the speed until you're ready to take on any alien around, and zap them before they zap you.

However, I did find an interesting use for the Slomo that wasn't simply restricted to increasing your hi-scores. I was playing Knight Lore (as usual) when it occurred to me to hit the freeze frame button just as I moved from one room into another. By doing this and then slowly turning up the speed dial, I was able to watch as the new room was slowly built up on the screen and overlaid onto the previous room. This process turned out to be quite fascinating, and when I tried it out with some other games it was interesting to compare the techniques used by authors to produce their screen displays. If

you're at all interested in machine code, then just watching this process would probably be interesting for the techniques it reveals.

Similarly, the Slomo's instructions contain a short program for printing numbers onto the screen, and using the Slomo at very low speeds revealed how the Spectrum builds up characters on screen, which is useful to see if you're at all interested in the inner workings of the machine.

I'm not sure that I can recommend the Slomo as an absolutely essential peripheral in the way that, say, a joystick probably is. But if what I've said about it appeals to you, then why not try it? It's a well constructed device, simple to use, and reasonably good value for money.

C.J.

Price: £14.95

Publisher: Nidd Valley Micro-products

Address: Stepping Stones Hse, Thistle Hill, Knaresborough, N Yorks

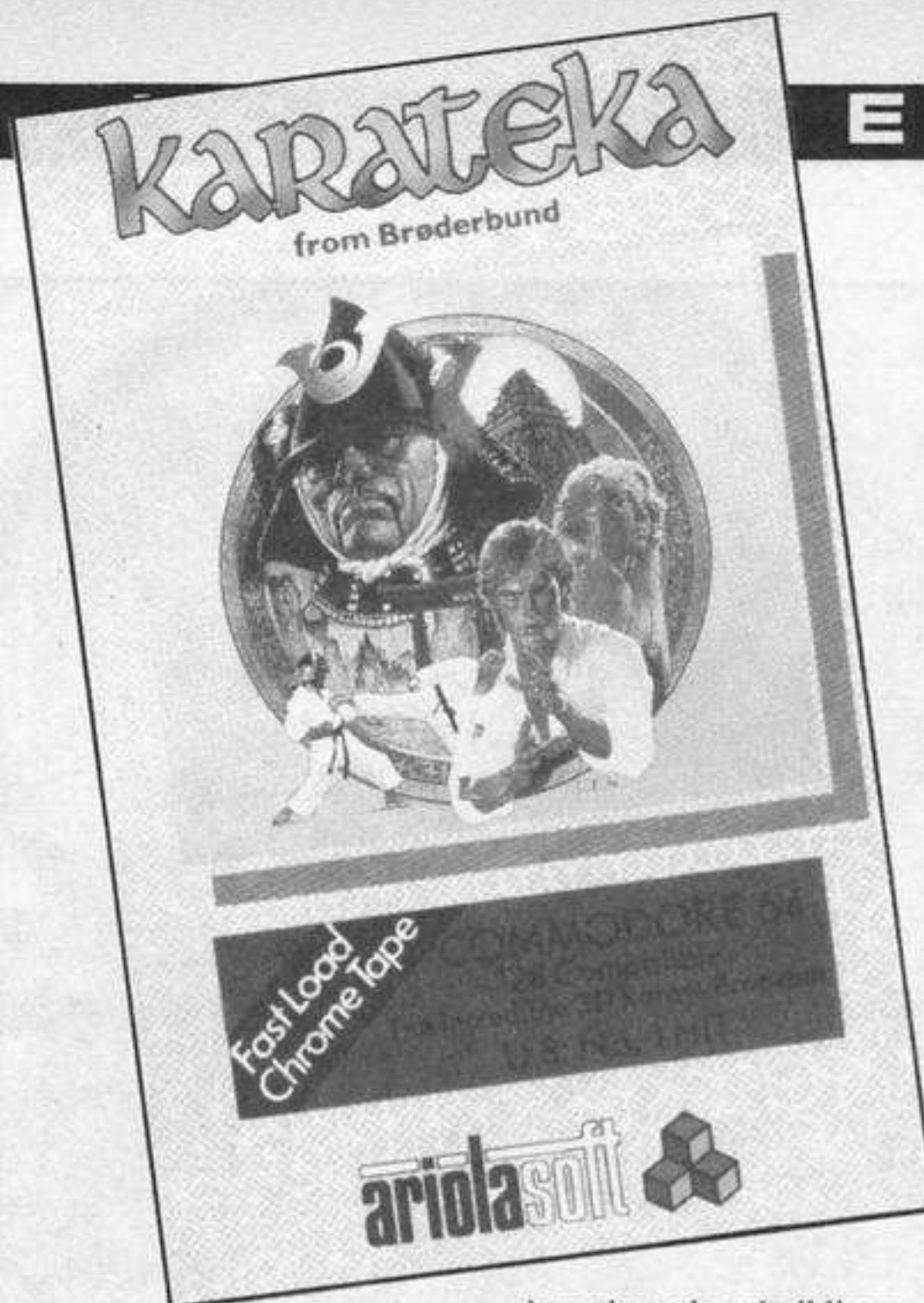

SOFTWARE

**Karateka**

This must surely be the ultimate in animation on the C64. The movements of the karate fighters are extremely realistic and the inclusion of a narrative cartoon adds to the realism.

You play the role of a master of the art of karate, Karateka, whose task is to rescue Princess Marika from the clutches of the evil Lord Akuma. She is imprisoned in the deepest dungeon of his castle which is perched on top of a cliff and guarded by his best troops.

The story starts with the imprisonment of the princess and this gives a taste of the quality of the game's visualisation. After the scene is set in this way the next part of the game is loaded. This is a feature of the game, each section of the castle is stored separately on tape and loaded as required. The sections do not take long to speed load and I found the system relatively easy to use.

The game starts as you climb over the top of the cliff to be faced with the first palace guard. As guards go he is not the most agile of people and does not pose too much of a problem. On entering the castle grounds you must then tackle more guards as you fight your way across the courtyard and

into the palace buildings.

Once inside the door closes behind you and you must fight hard not to be pushed back against it, making an easy target for your adversaries.

The karateka has two modes of readiness. To advance quickly he can run but if you meet an enemy while off your guard in this way, he will fell you with one sharp blow and you have to reload the game and start from the beginning. The best tactic is to drop into the fighting mode at the last possible moment, thereby maximising your advance and reducing the time it takes to clear each section and the number of guards met on the way.

You must also be on your guard against the unexpected because there are several extra problems to be overcome. Attacks by Akuma's trained eagle and learning how to pass a lethal bamboo portcullis or an apparently impassable doorway to name but three.

The moves of your player are limited to high, low and middle chops and kicks, and the additional problems presented in the game, with the superb quality of the animation makes this stand out as the best karate simulation game currently available.

Price: £9.95

Publisher: Ariolasoft

Address: Suite 105/6 Asphalte Hse, Palace St, London SW1E 5HS

**Schizofrenia**

This game is well named because I'm in two minds about it. Although I love the idea behind it and the quality of the graphics and sound, I find it extremely difficult to play.

The plot follows the story of Alphonse T. Nurd who, like the Sorcerer's Apprentice, cannot settle in his humdrum life and fiddles about with his master's latest gadget. This has the unfortunate effect of splitting Al's personality so completely that two of him exist at the same time.

All is determined to do something to correct the unfortunate situation while Al2 tries to be as awkward and obnoxious as possible. If you buy this game be careful because if the two Als meet then evil Al gives good Al a swift kick across the shins.

The game has five scenarios but since I couldn't get past the first I can't say a lot about those. No doubt someone at Quicksilva knows the secret but I enjoyed just wandering around having Al2 undo everything I made Al1 do in his attempt to save himself!

A strange game but at least it displays a sense of humour. Even the cassette insert is schitzoid.

J.G.

Price: £7.99

Publisher: Quicksilva

Address: 222 Regent St, London W1R 7DB

C64



C64





Chop Suey

If the idea of beating the living daylights out of some poor defenceless opponent appeals to you, then try a different game. The computer controlled player here is definitely not helpless.

After the first three levels, this martial arts game really picks up. All movements are controlled by the joystick and can take some getting used to, so it is worth practising on a "dummy" opponent before taking on the computer.

The action takes place in a colourful but rather dull setting. The two fighters compete in a shaded rectangular box in the middle of the screen watched by a small audience. The colour of the box changes to indicate when a new level has been reached. This is achieved by pounding your opponent until his residual pain level is high enough to make him submit within the three minutes allotted to each bout.

The sound effects are quite limited. A series of appropriate thuds and bleeps accompany the fight and a catchy tune plays over the title page.

There are a couple of features that I don't like. First, there is no way of selecting a starting level, and fighting your way through all the levels every time rapidly becomes annoying. However, my main complaint is that the two contestants are absolutely identical. In a fast and frantic bout it is all too easy to lose track of which player you are trying to control. This problem mars an otherwise very playable game. **K.F.S.**

Price: £8.95

Publisher: English Software Company

Address: 1 North Parade, Parsonage Gdns, Manchester M60 1BX

ATARI

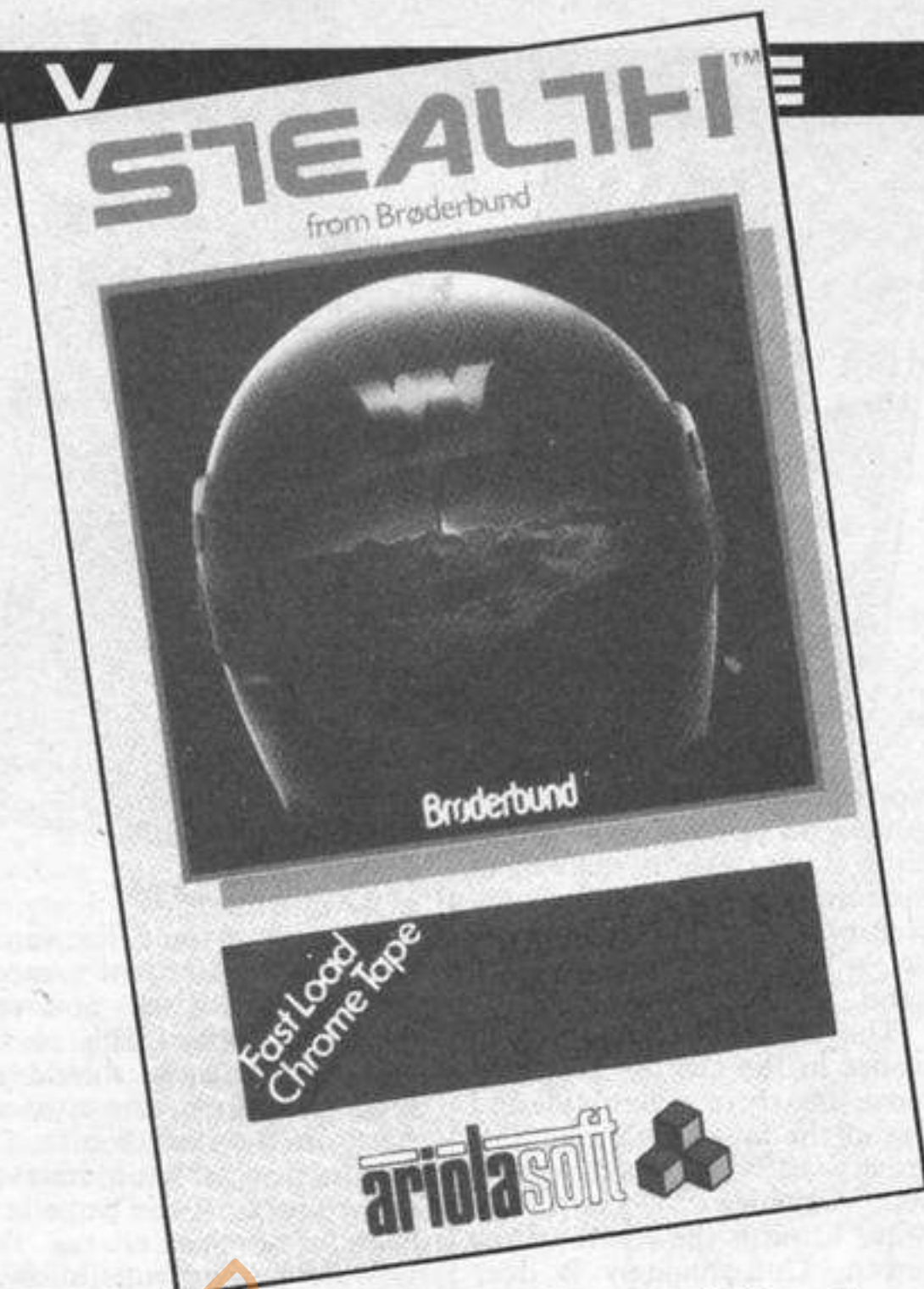

Stealth

When I saw Stealth at the PCW Show, I knew I would be reviewing it and decided my description would be something like "Buck Rogers" with knobs on. However, I've played it now and it's knocked me into the 21st Century.

I have seen many of these 3-D low flying aircraft arcade games before but none are as convincing and exciting as this. The enemy come right out of the screen at you and the speed is tremendous.

As commander of a space ship you watch as your craft flies towards the black tower on the horizon. This is today's target and the enemy are not going to let you zoom in like a Sunday driver on a spree. Radar installations block your path as tanks, bunkers and scout planes zero in on you, guns blazing. At higher levels these are complimented by amazingly realistic guided missiles and fighter planes with a smattering of volcanoes dotted around the landscape.

As you fly your energy is drained and must be replenished by flying through positive energy clouds but there are also negative clouds which will sap

your power supply if you fly too near.

The graphics are really convincing and I feel that this is the definitive version of this type of game. Especially worthy of mention are the missiles which seem to grow in size as they approach. A growth which builds as smoothly as the screen scrolls ever outward.

As you approach your objective the distance is indicated on the screen and you have three chances to reach it. Now the action becomes exceptionally hairy as you try to keep the tower in your sights while avoiding the enemy attacks by weaving to and fro. Success is rewarded with the sight of the tower exploding and you watch as your craft zooms off impressively into the distance and swings upward into the sky.

The opening screen gives the scoring system and also allows you to select any of the first three screens. Although I originally thought that the first two were exceptionally challenging, the third screen is a challenge and a half and I've yet to complete the fourth. Evidently the bunkers change at level five so you'll have to excuse me I must be off on my next mission. **E.D.**

Price: £9.95

Publisher: Ariolasoft

Address: Suite 105/6 Asphalte Hse, Palace St, London SW1E 5HS

C64



Flipped



Hooked



Keen



Yawning



Comatose



The Castles of Doctor Creep

Doctor Creep has 13 castles and they provide an intellectual touch to the normal ladders and platform games which litter the software market at the moment.

Each castle is a puzzle which has to be solved before you can reach the exit. Most of the rooms can be opened by pressing the doorbell outside but some are locked and the key must be recovered. To do this you must brave the perils of lightning machines, force fields, trapdoors, moving walkways, and ray guns. Mummies and Frankenstein monsters lie in their tombs waiting to be awakened into terrifying life.

All of these hazards have to be controlled or contained in some way so that a pathway is created to reach the keys and find the exit. To solve each castle you must explore every room because although the solution lies in a particular room, it can only be achieved by returning to various platforms from other rooms.

If the two players option is selected they must work in conjunction with each other unless they want to enjoy chaos. A partly completed game can be saved to tape.

The only qualm that I have about this game is what to do with it when the castles have been explored, perhaps some sort of game generator would have given it a more lasting appeal. **J.G.**

Price: £9.95

Publisher: Ariolasoft

Address: Suite 105/6 Asphalte Hse, Palace St, London SW1E 5HS

C64



Vortron

Vortron is a game that requires quite a lot of careful manoeuvring if you are to succeed in mastering it. As play is only controlled by using the joystick you will also need a good steady hand.

The screen contains a small planet in the centre. You may move anywhere around this and fire at the invading aliens. The gravity of the planet causes your missiles to constantly move towards the centre of the screen. Unfortunately it does not have any effect on your movement, it could be fun if it did though!

The aliens come in various shapes and sizes and move in different strategic patterns, you will eventually learn to use these to great effect. Touching the aliens will lead to your destruction. So you think that sounds easy! The problem is that your ship acts under inertia and once you have built up speed it takes quite a lot of stopping.

The sounds are excellent and demonstrate the capabilities of the CBM64 to the limit. This cannot be said of the graphics though; the shapes are large and simple. The background is quite good, however, giving a vortex effect.

The instructions supplied are printed on the back of the inlay card and are very straightforward. Unfortunately, the names of the aliens are not given.

At first sight I found Vortron quite boring. As I had to give it a fair review I started playing, and now find it quite a tactical challenge and not bad value for money. **K.I.**

Price: £2.99

Publisher: Budgie

Address: Rino Marketing Ltd, 1 Orange St, Sheffield, S1 4DW

C64



Raskel

It's been quite some time since I have had an excellent game to review that also sells at a very reasonable price. This shoot-em-up space game should get quite high up in the software charts in the near future if it gets the success that it deserves.

The object of the game is to defend your power rail that runs along the planet surface; you control a space ship that flies above this. Using a limited amount of energy you must kill as many aliens as possible before you get vaporized or the planet gets destroyed.

The screen scrolls sideways in the direction that you are moving and displays some very interesting graphics (Jeff Minter eat your heart out). A nice feature is the inertia that is used in the movements.

I found that the game is loosely based on a similar arcade machine called Defender. Raskel is certainly as addictive and contains graphics and sound of an equal quality. The instructions are good and simple, a lot of the game you will have to work out for yourself. A joystick will be needed to play in conjunction with the keyboard. I found that a Quickshot II worked well — fast reactions are needed.

The main menu page could do with tidying up but the playing screen and instructions pages are up to a good standard, even though the instructions do not appear for long enough to let you read them. **K.I.**

Price: £2.99

Publisher: Budgie

Address: Rino Marketing Ltd, 1 Orange St, Sheffield S1 4DW

C64



Physics

Revision Software Physics is written for "O" Level and CSE students and comprises two tapes of revision questions and screen simulated experiments.

One essential ingredient for any educational program is a format which presents a learning situation in a way which maintains a desire to find out what happens next. In this respect these programs succeed admirably, but flexibility is also essential.

The programs do not allow enough freedom in respect of the route a user can take through exercise. For instance, I could find no way of bypassing a section. All the exercises have to be worked through and all the questions answered correctly before moving on to the next section.

There were many misleading responses and questions which should have been edited out before publication. For instance a screen response to an answer should be "correct" or "wrong", not "yes" or "no" which can be very confusing if the question asks for a "yes" or "no". In another instance a multichoice question asked for an ordered list of items which would enable chemical energy to be stored using a steam kettle as an energy source and didn't include a turbine in the list.

However, the programs are clever and in many cases fascinating, especially the section on radioactivity. Experiments are animated and interactive, and a tremendous amount of information and activity is compressed onto the screen; so much so that it becomes a bit confusing at times but, despite this, the programs are a valuable revision resource and well worth the money. **J.D.**

Price: £11.50

Publisher: Charles Letts & Co Ltd

Address: Diary Hse, Borough Rd, London SE1 1DW

BBC





Q-Man's Brother

Spent all your cash on a BBC and nothing left to buy games? Blue Ribbon rush to your assistance with this graphically good spin-off in the Q-Man soap saga. Instead of hopping round an Aztec pyramid, Q-Man's Brother hops round an aerial walkway, but the goal remains the same. Turn the square a different colour, and avoid the predators. In this game you are pursued by a multi-coloured bucket and a paint roller which erases your squares. To help you keep on top of things, smart bombs are available in limited supply, with a new one after each screen. Colour is used to good effect, as is an impressive sound performance, and the graphics are polished, with the exception of le frere de Q-Man, who sports an awful pair of Polaroids.

This game is not for the hardened arcade-adventure. The aliens come down one at a time in monotonous regularity, some times occupying the same square as your imminent new life, and there seems to be no variation in layout apart from colour. One good design seems to be no variation in layout apart from colour. One good design detail is the ability to re-stat the game after pressing BREAK by accident, and the low cost makes pirating virtually unnecessary. I would recommend this game for new BBC owners and younger video freaks who can bash away for hours quite happily, but don't come in this direction in the quest for originality. **D.A.**

Price: £2.50

Publisher: Blue Ribbon Software Ltd

Address: Silver Hse, Silver St, Doncaster

BBC

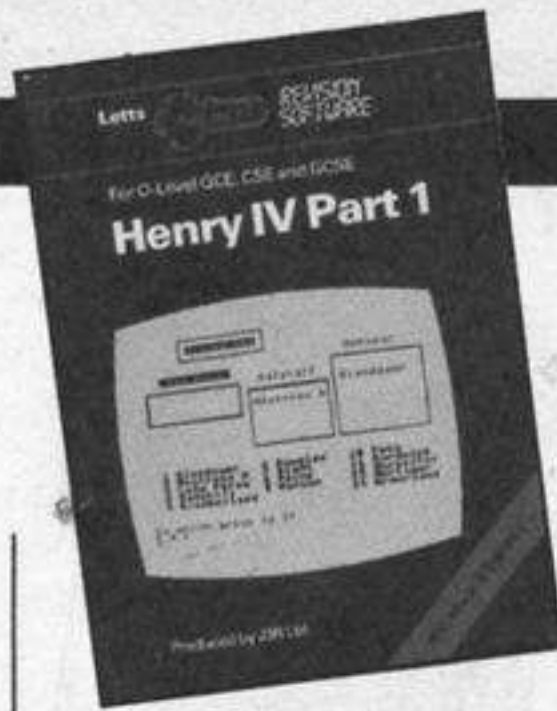

Henry IV Part 1

This teaching package of two tapes holds revision programs for "O" Level and CSE students of Shakespeare and contains a surprising amount of information and study exercises. I wouldn't have thought it possible to produce meaningful programs for Shakespeare's plays but I was impressed by the presentation and usefulness of this package.

Shakespeare packs so much into his plays that one reading is not sufficient to absorb and sort out the plots let alone their meaning. These programs have three main aims; to test by questioning; to present learning text; and to give the student an appreciation of the meaning and setting of the play.

The first tape places the play into its historical context and uses a family tree to illustrate the political tensions which mould play. It develops an understanding of the relationships between the various characters before finally attempting to sort out all the plots. All through the text, questions are posed and comments are given with different coloured text giving emphasis to the various teaching points.

Chunks of text with missing words are then presented for the student to fill in. The student can choose the text and degree of difficulty. Predict rate one is the hardest with only dashes to represent the words. The second tape holds two very long programs which, by means of quotations, leads the student to a deeper understanding of the play.

Although it has a limited market this impressive package presents students of Shakespeare with a valuable teaching resource. **J.D.**

Price: £11.50

Publisher: Charles Letts & Co

Address: Diary Hse, Borough Rd, London SE1 1DW

BBC

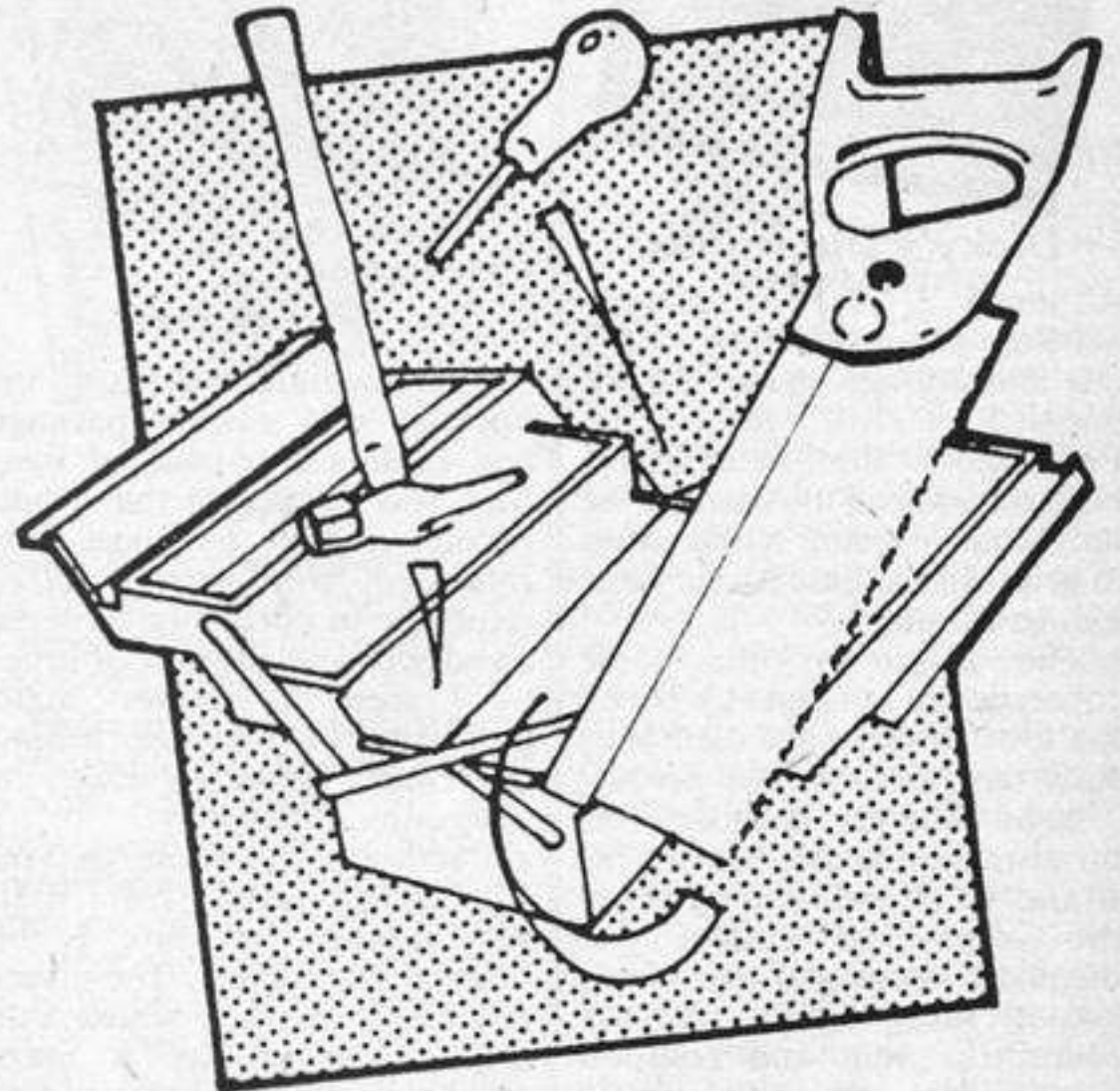

Maxam

This comprehensive machine code development system comprises three parts.

Primarily, the assembler program compliments the computers firmware and is fully compatible with Locomotive BASIC.

User friendly throughout, both 40 and 80 column screen resolutions are used. These provide a clearly legible display at all times. Colour enhances the mode 1 displays, making for very easy reading of the several columns of assembly language program.

In use the new command iASSEMBLE prefixes the mnemonics of the machine code sub-routine within a BASIC program, line numbers being used for each line just as in the BASIC program.

Hexadecimal notation is used throughout with the monitor program PEEKing at every memory location in RAM. ASCII characters are displayed alongside the contents of each location where appropriate.

Price: £26.95 (disc)

Publisher: Arnor

Address: PO Box 619, London SE25 6JL

Alongside this, a powerful Text Editor program and Basic program can be resident at the same time with individual editing facilities available to either program.

The instruction book explains in depth the use of the numerous command words unique to Maxam, with many programming examples. All these command words are listed together towards the end of the book-making for speedy reference.

If you curiosity has been sufficiently aroused by reading one of the numerous books giving an insight into the Z80A CPU then the purchase of an assembler is your next step towards machine code programming.

Maxam is published on ROM, Disc or Cassette, the price quoted below being for the disc version as reviewed.

With the software market in the doldrums and there being several other versions of assembler on sale, it may well pay you to shop around. **D.H.**

AMSTRAD





Dicky's Diamonds

Although I received a tape marked pre-production copy, this is not a new game. Romik released it two years ago. Presumably the rights have been transferred to Atlantis, the only change being a reduction in price. In any case it's no great loss to Romik.

The theme of the game concerns the attempts by Dicky the Owl to get eight diamonds back from Stephen the Spider. This he achieves, if he's clever, by dismantling Stephen's web, strand by strand, ending up in the centre to collect the diamond hanging there. Needless to say, Stephen marches round the web and collision with Dicky ends the owl's attempt — owl-killing spiders are a new breed I guess.

Where he can, Stephen patrols the remaining web, but if he reaches a dead-end he starts respinning, reducing Dicky's points as well as adding to his task. It needs a lot of planning, skill and luck to avoid this happening, particularly since if the final strand dismantled does not take Dicky to the web centre, his efforts are all in vain. Further complications include a penalty for Dicky hesitating; Stephen makes a beeline towards him, usually respinning the web as he does so.

The graphics aren't special, in fact there is nothing to make it stand out for rest of the pack. The insert does claim that there are starting levels for all abilities, but I would rather dispute that. I suppose if you want a real challenge at a cheap price, it's worth a go. **B.J.**

Price: £2.99

Publisher: Atlantis Gold

Address: 18 Prebend Street, London N1 8PF

C64

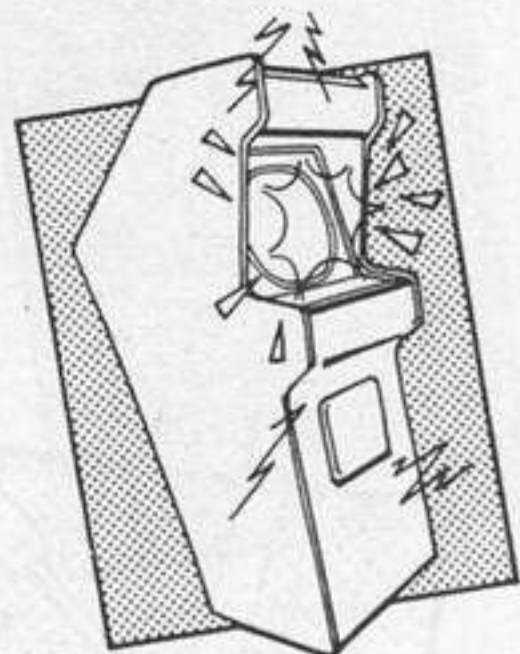

Pac-Man

My immediate reaction on opening this review package and finding a re-issue of Pac-Man was to suspect that I had become victim to some unintended time-warp. After returning to normality — never an easy task at the best of times — I spent a sleepless night pondering on the logic behind US Gold's generally excellent marketing philosophy.

Pac-Man, for those of you who have returned from a 10 year vacation on Mars, is the original maze game. The player controls a creature whose sole task is to wander a maze munching up the small dots liberally sprinkled around, which scores you points. Trying to prevent you are a number of other characters who roam the maze, contact with your muncher losing a life.

Consumption of power pills, dotted in far-flung corners, enable the player for a short time to turn on these foes and eat them for extra points. Once a maze is cleared of dots, it's on to an identical, but faster, screen — little animated sequences occur periodically between certain "milestone" mazes.

This is undoubtedly a very well presented version of the original vastly popular arcade game. I cannot help but feel, however, that with the excellent state of other software available — amongst them many other US Gold titles — the purchase of this is a piece of pure nostalgia.

Price: £9.95

Publisher: US Gold

Address: Unit 10, The Parkway Ind Ctre, Heneage St, Birmingham

ATARI



Nightmare Maze

The hero of the scenario, Sleepy Joe, must make his way around the maze collecting the eight keys required to open the Dark Door of Deeper Sleep and progress to the next level. Unfortunately for Joe he is not the only occupant of the maze. The pathways are strewn with Springy Things which bounce around the maze emitting a loud boinging noise. There is no fear of Joe falling asleep in this game.

Occasionally a cup of black coffee will appear at random positions around the maze. Touch the coffee and the bouncing beasts will disappear for a short time allowing Joe to collect his keys unhindered. This facility is essential as it is infuriatingly difficult to collect all of the keys within the time limit.

One slightly irritating point about the game is the fact that when a life is lost, the keys already collected are also lost, so you must start all over again with eight keys to collect. Once the key counter has reached zero it is time to make a quick dash for the door. This will then open and allow you to tackle the next, more complex, maze and it's inhabitants.

The graphics of this game are drawn using a 3-D shading effect; the floor of the maze has depth and all moving characters a shadow. This is particularly well done and drags the game out of the Pac-Man clone category. At the price of £2.50 Nightmare Maze represents excellent value for money. **J.R.**

Price: £2.50

Publisher: Blue Ribbon Software

Address: Silver Hse, Silver St, Doncaster, S Yorks

BBC

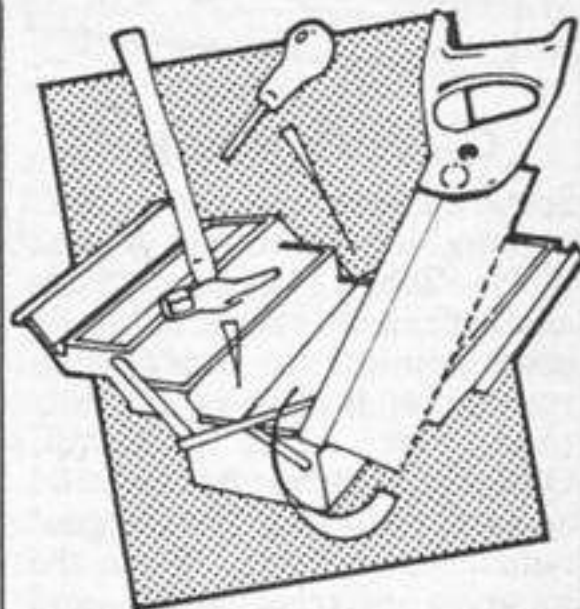

PsiFile

PsiFile is a database package allowing easy storage of almost any information the user requires, and equally simple manipulation of records.

The package is menu-driven and gives the user first of all the chance to define his own record structure, using the standard types set out in the manual. These types each have their own memory requirements, and each field may be set to being the key field, i.e. the field on which the list is manipulated. All input is virtually error-proof and there is a full edit facility. Once a file has been created it can be saved, of course, and a number of search facilities are also on offer, including a set of wild cards, which are very useful indeed. Full printing facilities are available, including selective printing of fields, and the record output format is automatically ordered.

I found PsiFile very easy to use, and anyone with little or no computer knowledge could use it, making it ideal for business or hobbyist use. The only criticism is that this cassette version is a bit slow to load and save files. **D.A.**

Price: £11.90

Publisher: Haiku

Address: Dragon Gate, 77 St John's St, Hayle, Cornwall

BBC



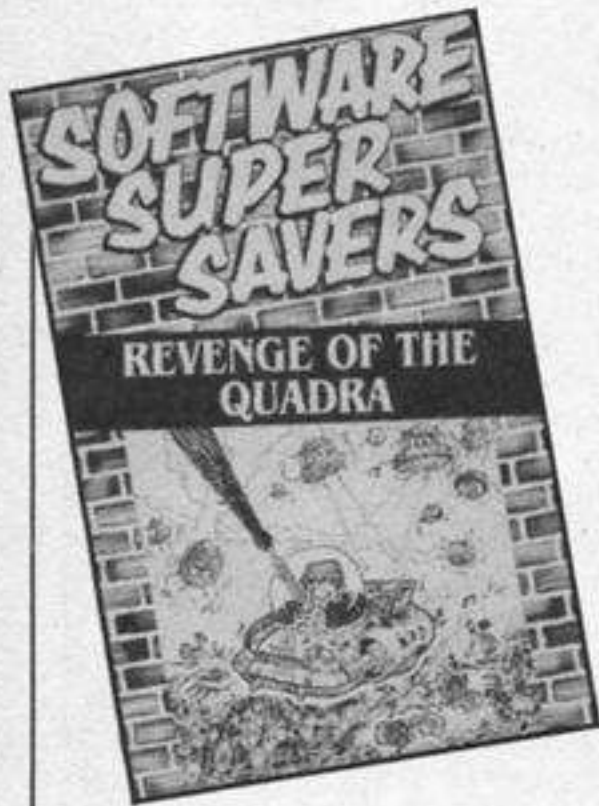

Revenge of the Quadra

With the demise of the VIC-20, it's nice to see some software houses bothering to produce new products. This game is one of the new breed of budget software and as such does itself proud.

It is a straight-forward shoot-em-up game with lots of nasty aliens who try to snatch humans from the bottom of the screen. Your task is to protect these humans. The majority of aliens gaily zip across the top of the screen. The occasional nasty, however, drops down and snatches a human.

You can redeem things by blasting the alien before it returns to the top of the screen. There are other nasties which simply drop down the screen and shoot you on sight. Each subsequent screen gets faster and much nastier.

This is a high speed action game for the real arcade enthusiast. There are some nice Minteresque graphical touches and the game has an excellent feel. This is one of the best VIC games I've seen for some time and at the price, unbeatable value. My one criticism is the almost total absence of instructions.

A.W.

Price: £2.99

Publisher: Software Super-savers

Address: Bearbrand Complex, Allerton Rd, Woodton, Liverpool L25 7SF

VIC-20

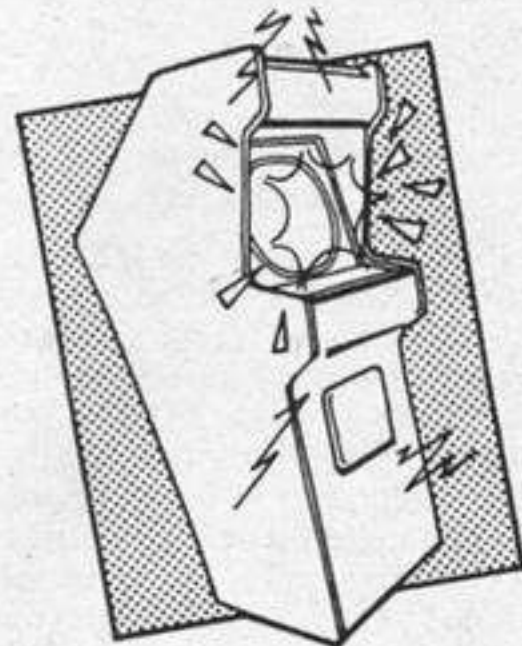

Cylu

Cylu is a sort of budget version of Alien B, in which you have to manoeuvre a blob on legs around a maze, collecting various objects in order to prove your worth as Warlord of an extraterrestrial race, or something like that — the plot is more or less disposable anyway.

Also scattered along the way are a number of micro-processor chips which can be used to activate teleport beams, and to disable forcefields, in order to allow you access to remote areas of the maze.

Like Alien 8, this game has three dimensional graphics, but these aren't clear or as varied as those in Ultimate's games. All the objects in Cylu seem to be boxes of one sort or another, are drawn with just straight lines and little use is made of shading, which would help to break up the monotony of the colours used.

There's no joystick control available, and I found the keyboard controls quite fiddly as there are quite a few options available to you when playing. You can "Examine" and "Use" objects, which is something that even Ultimate haven't included in their 3-D games.

It's difficult to judge this game actually. It can't compete with the likes of Alien 8, which is what it most resembles, but on the other hand it does only cost £2.50, and compared to other budget games you could do a lot worse.

C.J.

Price: £2.50

Publisher: Firebird

Address: Wellington Hse, Upper St Martin's Lane, London WC2

SPECTRUM

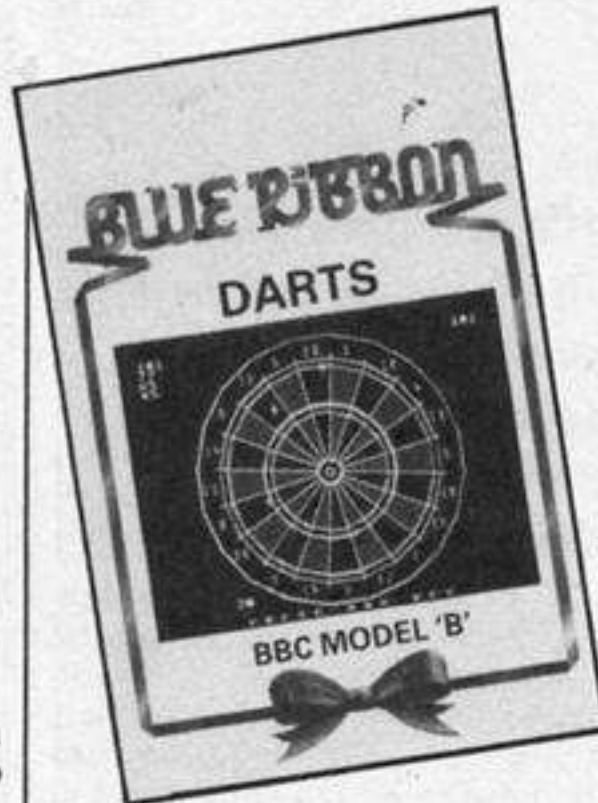

Darts

Jocky Wilson would choke on his upper plate at the idea of computerised darts, and I for one don't blame him.

There are some sports which, when reduced to pure technique become pointless and dull, and darts is one of them. Mind you, some software houses insist on bringing out versions anyway, and this one from Blue Ribbon is, unfortunately, not one of the better ones. The display is a simple black/white/red board with two score displays. Three games are optional, 501, Round the Bored (sorry) — Board and Cricket.

The programmer has obviously watched TV darts extensively, because the ideal darts player to him is one with chronic dts. This is represented by a neurotically quivering cross-hair, which is a shame, as the actual graphics are quite crisp.

I'd like to say something nice about this game, but apart from the low price there really isn't a lot to rave about. Its only potential buyers are probably frail but enthusiastic old grannies who tune in to Saturday afternoon darts on television to lust over John Lowe's spare tyre. Take a tip from Eric "Fatbelly" Gutbucket and sink three triple vodkas instead.

D.A.

Price: £2.50

Publisher: Blue Ribbon Software

Address: Silver Hse, Silver St, Doncaster

BBC



Speed King

Isn't it strange how many versions of one game you can find on the shelves of your local software shop. Speed King is a version of Pole Position that uses motorcycles instead of Formula One cars. The idea is to ride around a famous racing circuit and get the fastest possible lap time.

There are eight different circuits from all over the world. Each one has different backgrounds although there is no detail on the track itself to distinguish between them.

The game is played as if you were sitting on a motorcycle riding the circuit. The 3-D graphics give fast and smooth movement. The bikes lean on the corners as they bank round them. If you go too slow you will get lapped by the track leaders or even smashed off the road.

You have a total of six gears to use. The game may be played using either a joystick or the keyboard. I found that in practice it is far easier with the keyboard.

The software is protected by a number code entry scheme. You have to loop up a certain code on the inlay card when the game starts up. The list of codes cannot be photocopied, thus making protected versions rather hard to run.

Although the game is very good and contains no bugs, it does seem rather expensive at £9.95 considering that the graphics could be much improved.

K.I.

Price: £9.95

Publisher: Digital Integration

Address: Watchmoor Trade Ctre, Watchmoor Rd, Camberley, Surrey GU15 3AJ

C64



IT'S A GAME

It's all drops of INK in the bucket in this week's game writing article for Amstrad owners from David Ellis

In the last article we saw how movement could be accomplished by printing characters at various parts of the screen. The limitation here is that the more characters you have to move, the slower the movement will become. This is especially so if the program is written in BASIC. If it is written in machine code, then this is not likely to be such a problem.

However, there is one technique available which will move objects very quickly, and from BASIC as well. This technique is known as Ink Switching. The actual changing of the INK colour in a PEN is done by hardware, so this is virtually instantaneous.

The program **THE TWO SQUARES** shows how this is achieved. The colours for the four pens are first set in line 20. Line 30 draws a square in PEN 2, which is currently set at BRIGHT CYAN. Line 40 draws another square to the right of the last square in PEN 3. This is currently set to BLUE. As this is the present colour of the background the square is in effect invisible. It is however, still *there*.

Lines 50 to 80 now set up a continuous loop. Line 60 sets PEN 2 to BLUE, and PEN 3 to BRIGHT CYAN. The left square will therefore become invisible, whilst the right square will now appear. Line 70 then switches back the colours, causing the right square to disappear, and the left square to re-appear. The switching takes places so quickly that it is necessary to slow it down by using the delay subroutine at line 2000.

This technique is probably most useful in MODE 0, as in this mode you have 16 PENS to play with. This means that you could have one PEN for the background, one for the foreground, and 14 "spare" ones which could all be set to the background colour. You could now draw 14 invisible objects, placed in such a way that when they are made to appear one after the other, a moving effect

is achieved.

The program **THE 12 RECTANGLES** demonstrates this. Firstly, 14 rectangles are drawn of increasing size in the 14 colours of mode 2 (PEN 2 to PEN 15 in subroutine 3000). This is repeated 11 times, giving 12 rectangles, each consisting of 14 rectangles of various colours. Line 70 waits for you to press any key... now the fun starts!

Subroutine 2000 is called repeatedly until you press another key, when the rectangles will revert back to their original colours. Subroutine 2000 works as follows:-

Two loops are used. The outer loop, "show", refers to the PEN used to draw the rectangles — the bigger the PEN number, the bigger the rectangle. The inner loop, "x", then sets all the PENS from 2 to 15 to background BLUE, *except* when it is equal to the variable "show" when that PEN number is set to BRIGHT CYAN. At any one time therefore, only one rectangle is visible, the remaining 13 being invisible.

The visible rectangle grows in size, giving the effect of movement. This is very similar to the warp gate effect in Dark Star. If you RUN the program you will see more clearly what I am finding rather difficult to put into words. Advantage is taken of the outer loop by using its values to produce a "spacey" sound.

The other program that makes use of this ink switching is called **BLOCKS**. This simulates the sort of effect that is popular on stage with moving lights. It was also a popular programming challenge in the good old TRS-80 days (remember the TRS-80?).

Line 20 sets the colour of three of the lights. PEN 1 is PASTEL BLUE, PEN 2 is BRIGHT RED, and PEN 3 is GREEN. Lines 40 to 110 draw a rectangle of blocks of the

alternating three colours. There are 90 blocks in all. The PEN number is set in line 50 by using the modulus of the number of blocks divided by 3. But we do not want PEN 0, so 1 is added to the total. CHR\$(43) is the graphics character for a solid block

The main program loops around lines 130 to 150. These are the three lines that do the switching of the ink colours, and give the effect of moving blocks. Once again, a delay is needed to slow things down. With a delay of 100, the blocks appear to move in an anticlockwise direction. If you alter the value of the loop you may find that the movement appears to be in a clockwise direction. To some extent, it depends upon your eyesight. You may think that the blocks are moving clockwise, whilst to someone else they may appear to be moving anticlockwise! With visual tricks you can never be sure.

The string "AMSTRAD CPC464" shows what colour PEN 1 is changing to. You may like to try and produce the same effect without the use of ink switching. Just limit it to alternate blocks of foreground and background colour to make it a little easier. Even so, I think you will find it quite a difficult problem. I know that on the ORIC (which is not able to ink switch) it was quite a problem, and was only solved by using machine code.

The ability to switch inks instantaneously is very useful as I hope you have realised from these simple examples. Some stunning effects can be achieved with a little planning, as demonstrated on the BBC, which also has this facility.

In the next article I shall be taking a look at the logical operations that are available on the AMSTRAD. These work on the colours (or to be more precise on the PEN number) and open up many interesting possibilities.

```
10 MODE 0
20 FOR times=1 TO 12:READ x,y
30 DATA 70,50,220,50,370,50,520,50
40 DATA 70,150,220,150,370,150,520,150
50 DATA 70,250,220,250,370,250,520,250
60 GOSUB 3000:NEXT
70 WHILE INKEY$="":WEND
80 WHILE INKEY$="":GOSUB 2000:WEND
90 CALL &BC02:END
1000 REM***** DRAW SQUARE *****
```



```

1010 DRAWR across,0,color
1020 DRAWR 0,down:DRAWR -across,0
1030 DRAWR 0,-down:RETURN
2000 REM***** SWITCH COLORS *****
2010 FOR show=2 TO 15:SOUND 2,0,6,7,0,0,show
2020 FOR x=2 TO 15
2030 IF x=show THEN INK x,20 ELSE INK x,1
2040 NEXT x,show:RETURN
3000 REM***** DRAW SQUARES *****
3010 FOR square=2 TO 15
3020 ORIGIN x,y:across=10*square
3030 down=6*square:color=square
3040 GOSUB 1000:x=x-4:y=y-2
3050 NEXT:RETURN
    
```

THE 12 RECTANGLES.

```

100 :IF place>75 THEN y=y-1
110 :NEXT
120 WHILE -1
130 GOSUB 1000:INK 1,6:INK 2,9:INK 3,14
140 GOSUB 1000:INK 1,9:INK 2,14:INK 3,6
150 GOSUB 1000:INK 1,14:INK 2,6:INK 3,9
160 WEND
1000 FOR delay=1 TO 100:NEXT:RETURN
    
```

BLOCKS

```

10 MODE 1
20 INK 0,1:INK 1,24:INK 2,20:INK 3,1
30 ORIGIN 200,200:color=2:GOSUB 1000
40 ORIGIN 302,200:color=3:GOSUB 1000
50 WHILE -1
60 INK 2,1:INK 3,20:GOSUB 2000
70 INK 2,20:INK 3,1:GOSUB 2000
80 WEND
1000 REM***** DRAW SQUARE *****
1010 DRAW 100,0,color:DRAW 100,100
1020 DRAW 0,100:DRAW 0,0:RETURN
2000 REM***** DELAY ROUTINE *****
2010 FOR delay=1 TO 500:NEXT:RETURN
    
```

THE TWO SQUARES

```

10 MODE 1:CALL &BC02:x=5:y=5
20 INK 1,14:INK 2,6:INK 3,9
30 LOCATE 13,12:PRINT"AMSTRAD CPC464";
40 :FOR place=1 TO 90
50 :PEN place MOD 3+1:LOCATE x,y
60 :PRINT CHR$(143);
70 :IF place<31 THEN x=x+1
80 :IF place>30 AND place <46 THEN y=y+1
90 :IF place>45 AND place<76 THEN x=x-1
    
```

For help with Reading and Writing
 **01-405 4017**

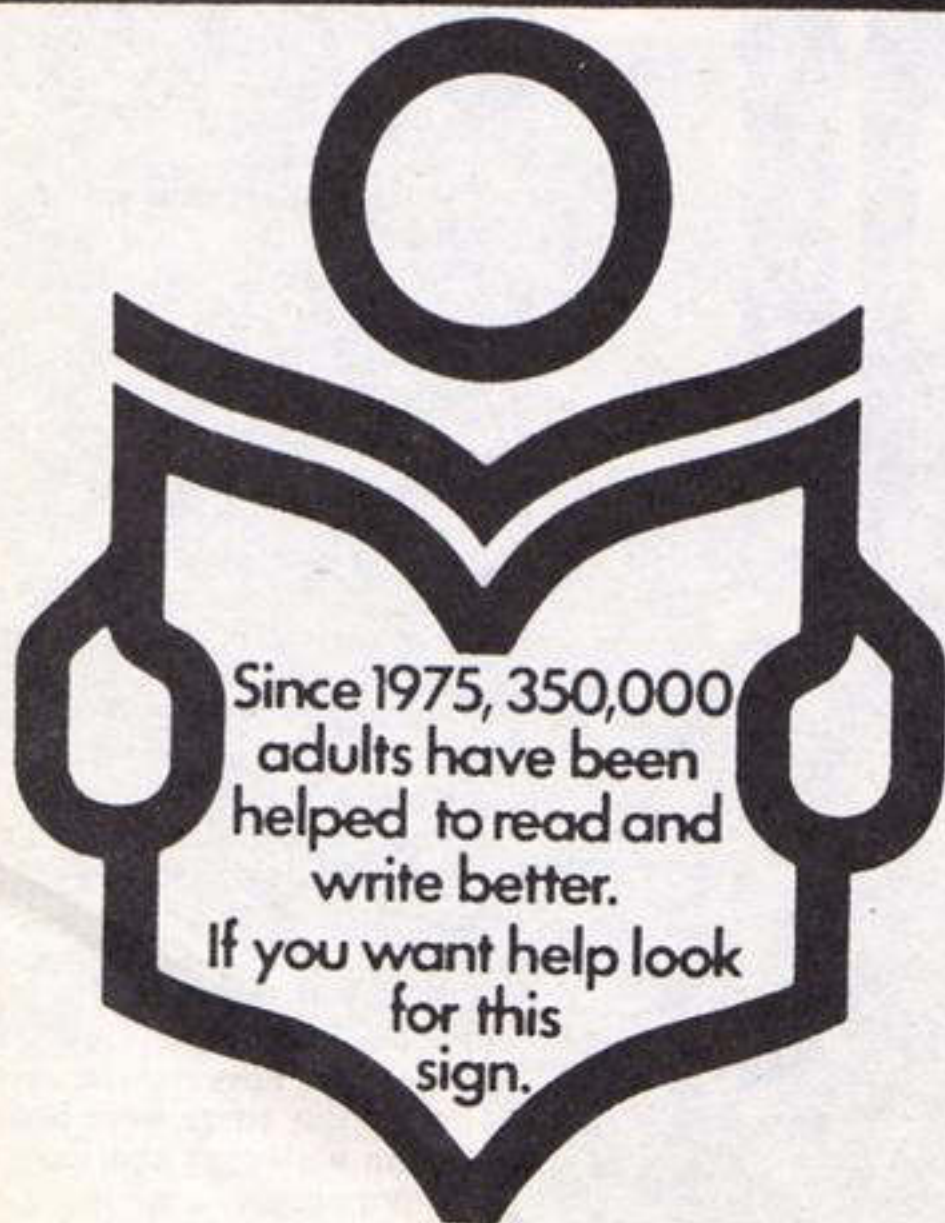

Since 1975, 350,000 adults have been helped to read and write better.
 If you want help look for this sign.

For further information
Adult Literacy & Basic Skills Unit
 PO Box 213 London WC1V 7ET

BYTE

SPECTRUM

GAME	RRP	OUR PRICE
FRANKIE G. T. HOLLYWOOD	9.95	7.50
A VIEW TO A KILL	10.99	7.99
SPY vs SPY	9.95	7.50
DUN DURACH	9.95	7.50
EXPLODING FIST	8.95	6.75
STARION	7.95	5.95
HYPERSPORTS	7.95	5.95
WORLD SERIES BASEBALL	6.95	5.25
BATTLE FOR MIDWAY	9.95	7.50
NOW GAMES	8.95	6.75
CAULDRON	7.99	5.99
SHADOWFIRE	9.95	7.50
AZIMATE 3000	4.99	3.95
ANIMATED STRIP POKER	6.95	5.25
ROCKY HORROR SHOW	8.95	6.75
ROCKFORDS RIOT	9.95	7.50
JET SET WILLY II	6.75	5.25
BORED OF THE RINGS	6.95	5.25
MATCH DAY	7.95	5.95
HIGHWAY ENCOUNTER	7.95	5.95
RED MOON	6.95	5.25
NICK FALDO'S OPEN	9.95	7.50
BATTLE OF BULGE	9.95	7.50
JUGGERNAUT	7.95	5.95
TALOS	7.95	5.95
DYNAMITE DAN	6.95	5.25
THATS THE SPIRIT	6.95	5.25
FAIRLIGHT	9.95	7.50
ROBIN OF SHERWOOD	9.95	7.50
SOUTHERN BELLE	7.95	5.95
SS COMPILATIONS (PSS)	4.99	3.75
INTERNATIONAL KARATE	6.50	4.25
CYLU	2.50	1.75
FRANK BRUNO'S BOXING	6.95	5.25
DALEYS SUPERTEST	6.95	5.25
PROFINATION	7.95	5.95
CODENAME MAT II	8.95	6.75
TRIVIA	7.95	5.95
TERREMOLINOS	6.95	5.25
DOOMDARK'S REVENGE	9.95	7.50
EXPLODING FIST	8.95	6.75
NOW SOFTWARE	8.95	6.75

COMMODORE

FRANKIE G. T. HOLLYWOOD	9.95	7.50
WAY OF EXPLODING FIST	9.95	7.50
VIEW TO A KILL	10.99	7.99
ELITE	14.95	11.00
NOW GAMES	8.95	6.75
JUMP JET	9.95	7.50
GRAHAM GOOCH'S CRICKET	9.95	7.50
HYPERSPORTS	8.95	6.75

GAME	RRP	OUR PRICE
THEATRE EUROPE	9.95	7.50
COMBAT LYNX	8.95	6.75
PSYTRON	7.95	5.95
TERROMOLINOS	6.95	5.25
SKYFOX (cassette)	9.95	7.50
WIZARDRY	9.95	7.50
CONFUZION	6.95	5.25
CODENAME MAT II	8.95	6.75
JOURNEY	7.95	5.95
JET SET WILLY II	8.95	6.75
WORLD SERIES BASEBALL	7.95	5.95
CAULDRON	7.99	6.50
RED MOON	6.95	5.25
NICK FALDO'S OPEN	9.95	7.50
BATTLE OF THE BULGE	9.95	7.50
THING ON A SPRING	7.95	5.95
ROBIN OF SHERWOOD	9.95	7.50
SS COMPILATION (PSS)	4.99	3.75
BEACH HEAD II	9.95	7.50
WIZARDRY	9.95	7.50
WIZARDSLAIR	8.95	6.75
INTERNATIONAL KARATE	6.50	4.25
CYLU	2.50	1.75
FRANK BRUNO'S BOXING	7.95	5.95
NODES OF YESOD	9.95	7.50
PSI WARRIOR	9.95	7.50

AMSTRAD

COMBAT LYNX	8.95	6.75
CONFUZION	6.95	5.25
EXPLODING FIST	9.95	7.50
ANIMATED STRIP POKER	8.95	6.75
VIEW TO A KILL	10.99	8.99
SORCERY	8.95	6.75
DARK STAR	7.95	5.95
3D STARSTRIKE	6.95	5.25
DUN DURACH	9.95	7.50
TANK BUSTERS	7.95	5.95
DRAGONTORC	7.95	5.95
RED ARROWS	9.95	7.50
RED MOON	6.95	5.25
AIR WOLF	8.95	6.75
FRANK BRUNO'S BOXING	8.95	6.75
EVERYONE'S A WALLY	9.95	7.50
BRIAN BLOODAXE	8.95	6.75
ALL AMSOFT DISKS	12.95	9.95

SPECIAL OFFER QUICKSHOT II £6.50

ALL PRICES INCLUDE P&P

PLEASE NOTE IF OUR ORDER EXCEEDS £50 YOU GET 10% FURTHER DISCOUNT

SEND CHEQUES/P.O. TO

GOODBYE HCW

94 LEATHER LANE, LONDON EC1

(TEL: 01-404 4245)

THIS IS JUST A SMALL SELECTION FROM OUR STOCK—PHONE FOR ALL YOUR SOFTWARE NEEDS

PD359

Here's the real low down on the show from our two raving — sorry roving — reporters who found themselves locked in Olympia for three days

IMPRESSIONS



Atari stands out

Fevered browsing

At the Cruft's of the micro-user world last week, the heat was definitely on. As a first time visitor to the auspicious occasion I did wonder if inadvertently I'd walked into the wonderful world of Disney but finally managed to see the purpose of a bedraggled Donald Duck, strangely feminine Mister-Men and a cockney Rambo doing marvellous things with his overdeveloped pectorals.

Film or TV connected games pulled the crowds and Ocean's slick video stand had even the most conservative computer-buffs bopping in the aisles to

the strains of Frankie. Less palatable and totally irrelevant were the go-go dancers no doubt demonstrating the intellectual capabilities of System 3's software range.

The anarchic Young Ones were on screen and either the stress of the show was all a little too much or the Buck's fizz too strong — but I'm convinced there was a blonde Neil. By far the most exciting game which managed to stand out against the incessant sound-tracks and blur of screens was Activision's Ballblazer with superb graphics and speed-effects reminiscent of a manic roller-coaster.

Noticeable by its absence was Sinclair's 128 but to overcome

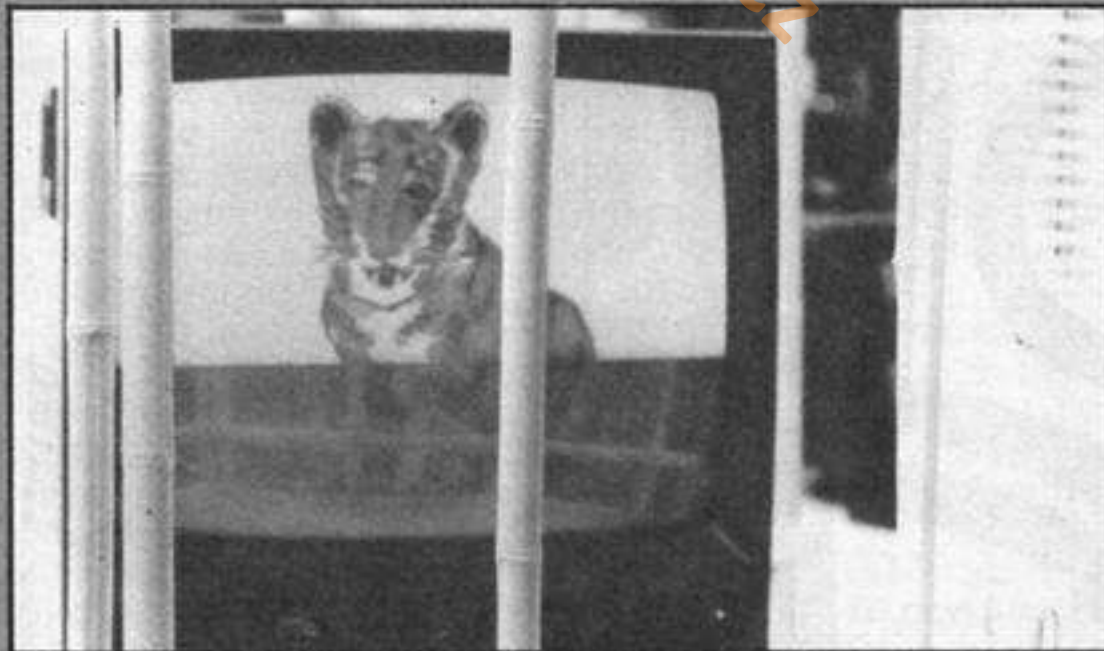

Tiger tiger talking bright

A quiet day at the show



the disappointment was a preview of Commodore's Amiga. Due for launch early next year the IBM compatible Amiga p.c. with superlative hi-tech, high-class graphics, was pure visual delight.

Apparently the show was lacking the buzz of last year but I still managed to develop a severe case of tinnitus which wasn't helped by Llamasoft's musical non-stop raves from the grave (who says hippies are dead).

As the pace slowed down like a carousel coming to a timely halt, U.S. Gold let the remaining fair goers rip their stand to pieces, Jack Trameil turned back into a cartoon, and Rambo nursed a broken fingernail.

One by one the lights dimmed, the cleaners rested on their silicon-driven brooms, and I pondered the invention of the abacus . . .

Lazy lounging

OK let's admit it you've all been wondering what PCW really stands for. I can now reveal all — it means People Can't Wait and this year's show was the epitome of the motto.

People couldn't wait to get through the doors, there were queues right around the side of the building on the public days. They couldn't wait for the games which were on show, although very few were for sale, most waiting to be finished. And they couldn't wait for the new Atari 520ST.

The ST was without any doubt the real interest of the show and in order to make certain that they got plenty of attention they had three, yes one more than two, islands amidst the sea of people.

There were Atari's running games, demonstrating communications, showing off their desk tops and running business programs. There were even Atari's with flower bees on their monitors — something to do with being busy I assume!

Another possible use of the PCW initials is the Press Can't Wait and when Jack Trameil the Atari boss showed up on the press day there were hoards of them with eyes and flash bulbs a-popping.

Jack was his usual effusive self with comments on software, hardware and the general state of the industry. He claimed that 50,000 ST's had

been produced worldwide and all had been sold as demand was far greater than supply.

What I hadn't expected was his praise of British software houses. "Britain has the best software developers in the world", he claimed and added that the ST software was likely to be available here a good two months before it was released in the US.

Some of you might be pleased to note that there will be a version of the ST with a normal TV output which will bring the price down to a home user's level. Jack claimed this would be available when they were ready to launch the machine to a mass market, unlikely to be before the middle of next year.

Another issue which concerned the press was the availability of the operating system and GEM software on ROM. The current machines have to have these parts of the system loaded from disc and this takes up valuable user memory. Jack reckons that the ROMS should be around early next year and that they will be made available to disc version purchasers at a price which has yet to be set.

While Atari had a great deal of attention there were a number of other manufacturers with new products to show. Few of the visitors to Amstrad's bright blue stand could have missed the 8256. There was a whole area where potential purchasers could try their hands at word processing on the cheap. Most came away impressed by the capability of the system at such a low price.

The disgruntled CPC 664 users seemed to be bending a few ears on the stand. They weren't too pleased with Mr Sugar's announcement of the CPC 6128 and his statement that the 664 was "truly dead!" I don't think that they had too sympathetic a hearing though.

The Acorn stand was surrounded for the whole duration by visitors who were attracted by the huge variety of peripherals and add-ons being demonstrated. The big news for Acorn aficionados was the new BBC B+ 128K at a rather hefty price of £499. Unlike those left high and dry by Amstrad BBC B+ owners with 64K machines will be able to get the 64K upgrade at around £30 fitted.

Other new products on the stand were few and far between but there was the long promised



Guess who?



Guess who part II?

GRX graphics extension ROM, an official Acorn 1770 DFS which can be used on the BBC B and the ADFS chip which allows double density recording when used with a 1770 based DFS system. There were rumours that the Electron is to be dropped but they are unconfirmed as yet.

Enterprise continued to live up to their promises with their new EXDOS disc operating system. If ever a company tried hard to revive faith in its products it has to be Enterprise. The special feature of the machine is its incredible capacity to become other machines and with EXDOS you can use discs of almost any format and size — a truly incredible feat.

They were also shouting about their software support. They launched 34 new games at the show and this brings the total to 60. Most of these are conversions of successful titles for other machines but should please the dedicated band of Enterprise followers.

The prize for innovation on the stand should go to Microvitec's talking Tiger. Kept behind a set of paper bars this screen based beast spent the entire show talking to those that walked by. There was always a crowd around his cage and the lip synched talk was truly captivating. Perhaps Microvitec will follow up their touch screen with a talk screen.

The overbearing memory of the show had to be the heat. The public days were packed with the pressing throng and there was the usual collect anything visitors who left with bulging carrier bags full to the brim with adverts and flyers. I have this picture of them all sitting at home with their carriers delving in every few days when they need another "fix" of hype.

Well, it's all over for another year and there is time to reflect and wait for the new machines to grab their places in the market. If you consider the advances that have occurred between the last show and this one perhaps next year we can look forward to 32 bit processors with 8 megabytes of memory, 32 sound channels, 256 colours selectable from half a million shades, built in hard disc drives, hi-res monitors and all with a price payable in cereal packet tops. Don't hold your breath!

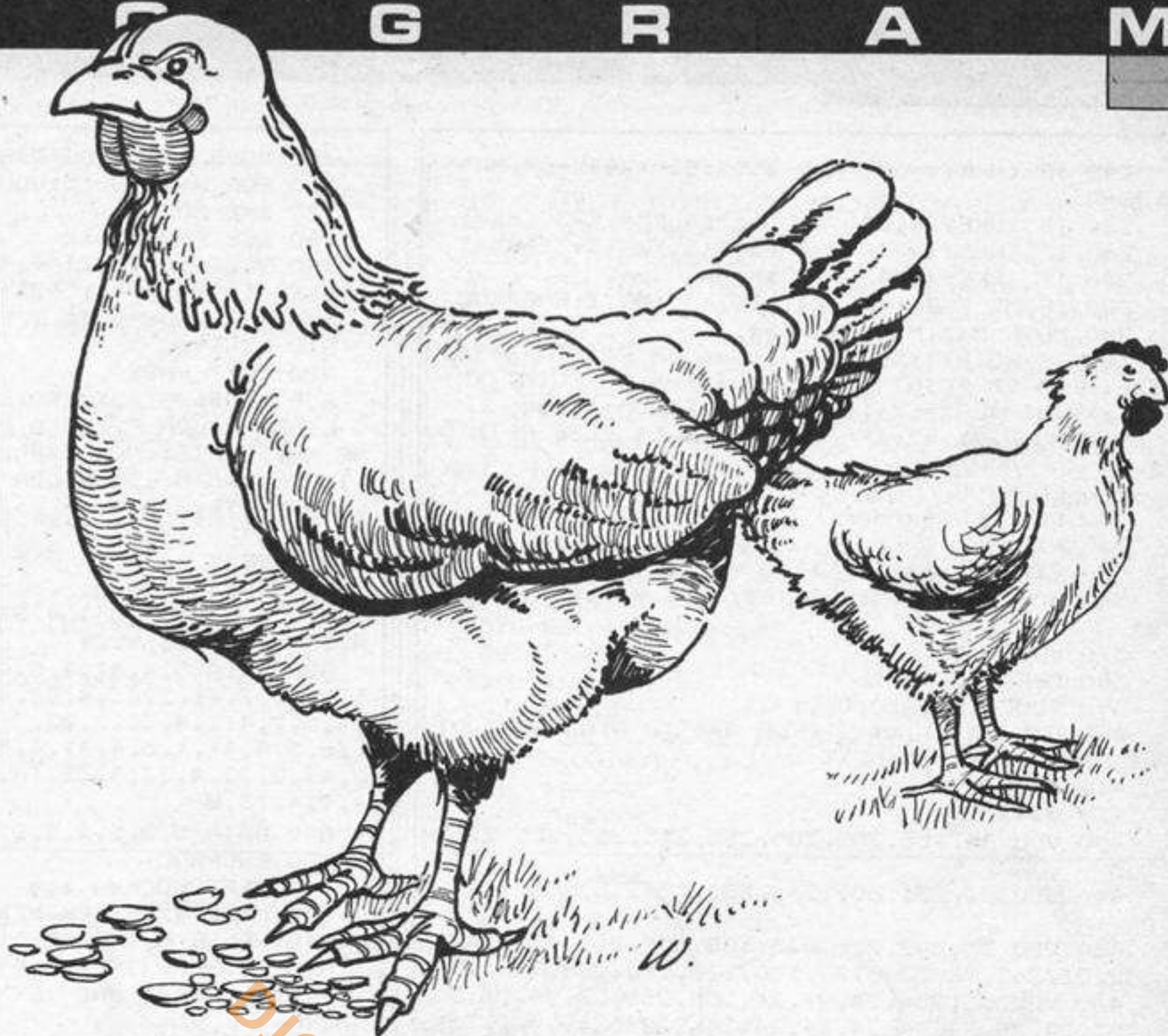

CHICKEN FEED

BBC GAME

The heroic chicken is in a fight for survival in this barnstorming farmyard game for the BBC by Stephen Gray

As a chicken, you must run around the farmyard collecting eggs. Your food supply is constantly running out, but to get five more units of food you can throw an egg up to the farmer on the fence. The game ends when you run out of food.

Controls

Z-left, X-right, *-up, ?-down, RETURN-jump, DELETE-freeze, COPY-continue

How it works

70-120 initialisation
 130-200 main loop
 210-320 chicken procedure
 330-370 farmer procedure
 380-620 initialisation procedure
 630-770 draw screen procedure
 780-900 interrupt driven music procedure
 910-980 print new egg procedure
 990-1170 throw egg procedure
 1180-1220 end of game
 1230-1480 high scores procedure
 1490-1560 instructions procedure
 1570-1640 freeze procedure

Variables

S% score	ZS food
E% eggs in your possession	ES egg on floor
F% food left	RS chicken facing right
X% Y% chicken's co-ordinates	LS chicken facing left
MX% MY% chicken's last co-ordinates	FS part of fence
M% did chicken move?	BS green block
J% which way chicken is facing	GS farmer
FX%,FY% farmer's co-ordinates	N notes counter location
PX% farmer's last co-ordinate	P start of music data
H%(5) high scores array	EX%, EY% co-ordinates of egg on farmyard floor
NS(5) high scorers' names array	TY% co-ordinate of egg being thrown
V% rank	FT time when game was frozen
KS egg which is being thrown	

```

10 REM *****
20 REM * Chicken feed *
30 REM * by Stephen Gray *
40 REM * BBC Model B *
50 REM * Grayface *
60 REM *****
70 MODE7:PROCinit:PROCmusic:PROCinstruct:P
ROChigh
80 ON ERROR *FX13,4
90 ?N=0:S%=0:E%=0
100 MODE2:PROCscreen
110 *FX14,4
120 TIME=0
130 PROCchicken
140 PROCfarmer
150 IF TIME>50 F%=F%-1:TIME=0
160 VDU4:PRINTTAB(12,1)::IF F%>9 PRINT:F% E
LSE PRINT:"0":F%
170 VDU5
180 IF INKEY(-90) PROCfreeze
190 IF F%=0 VDU4,17,11:PRINTTAB(12,1):"00":
FOR A=1 TO 5000:NEXT:GOTO 1180
200 GOTO 130
210 DEF PROCchicken
220 MX%=X%:MY%=Y%:M%=0
230 IF INKEY(-98) AND X%>0 X%=X%-64:M%=1:J%
=1
    
```

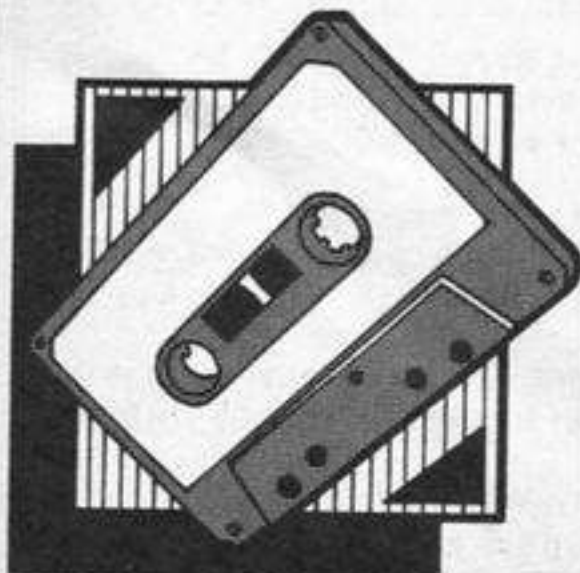

```

240 IF INKEY(-67) AND X%<1152 X%=X%+64:M%=1
:J%=2
250 IF INKEY(-105) AND Y%>64 Y%=Y%-32:M%=1
260 IF INKEY(-73) AND Y%<512 Y%=Y%+32:M%=1
270 IF INKEY(-74) PROCthrow
280 IF M% ELSE FOR A=1 TO 140:NEXT:ENDPROC
290 MOVE MX%,MY%:PRINTB#
300 IF POINT(X%+32,Y%-16)=4 OR POINT(X%+96,
Y%-16)=4 OR POINT(X%+32,Y%-48)=4 OR POINT(X%+
96,Y%-48)=4 EX%=E%+1:S%=S%+10:PROCnew_egg
310 MOVE X%,Y%:IF J%=1 PRINT L# ELSE PRINTR
#
320 ENDPROC
330 DEF PROCfarmer
340 FX%=FX%
350 FX%=FX%-64:IF FX%<0 FX%=1216
360 MOVE FX%,FY%:PRINTG#:MOVE FX%,FY%:PRINT
G#
370 ENDPROC
380 DEF PROCinit
390 VDU23:8202:0:0:0:
400 DIM H%(5),N%(5):FOR A=1 TO 5:H%(A)=100:
N%(A)="Grayface":NEXT
410 S%=0
420 @%=7
430 VDU 23,255,255,255,255,255,255,255,255,
255
440 VDU 23,251,60,126,255,255,255,255,126,6
0
450 VDU 23,242,228,238,138,202,202,138,142,
132,23,243,76,238,170,170,170,170,238,76
460 VDU 23,254,24,24,24,255,255,24,24,24,23
,253,24,24,24,24,24,24,24,23,252,0,0,0,255
,255,0,0,0
470 VDU 23,224,0,0,2,129,193,225,240,255,23
,225,168,168,240,208,252,252,240,224
480 VDU 23,240,60,60,255,0,36,0,60,0,23,241
,24,126,255,189,189,36,36,102
490 VDU 23,226,127,127,63,31,10,10,59,42,23
,227,224,192,192,128,0,0,128,128
500 VDU 23,235,0,0,64,129,131,135,15,255,23
,234,21,21,15,11,63,63,15,7
510 VDU 23,237,254,254,252,248,80,80,220,84
,23,236,7,3,3,1,0,0,1,1
520 K#=CHR#18+CHR#3+CHR#6+CHR#251
530 Z#=CHR#18+CHR#3+CHR#13+CHR#242+CHR#243
540 E#=CHR#18+CHR#0+CHR#4+CHR#251
550 R#=CHR#18+CHR#0+CHR#3+CHR#224+CHR#225+C
HR#8+CHR#8+CHR#10+CHR#226+CHR#227
560 L#=CHR#18+CHR#0+CHR#3+CHR#234+CHR#235+C
HR#8+CHR#8+CHR#10+CHR#236+CHR#237
570 F#=CHR#254+CHR#252+CHR#8+CHR#8+CHR#10+C
HR#253+CHR#8+CHR#10+CHR#253+CHR#8+CHR#10+CHR#
253+CHR#8+CHR#10+CHR#254+CHR#252
580 B#=CHR#18+CHR#0+CHR#2+CHR#255+CHR#255+C
HR#8+CHR#8+CHR#10+CHR#255+CHR#255
590 G#=CHR#18+CHR#3+CHR#5+CHR#240+CHR#8+CHR
#10+CHR#241
600 ENVELOPE3,1,1,-1,0,1,1,1,90,-1,-1,-1,90
,30
610 ENVELOPE2,1,22,-22,22,5,5,5,120,-3,-3,-
3,120,60
620 ENDPROC
630 DEF PROCscreen
640 VDU 23:8202:0:0:0:
650 FOR A=1 TO 15:VDU19,A,0:0:0:0:NEXT
660 COLOUR 1:PRINT"SCORE EGGS FOOD HIGH"
670 COLOUR 7:PRINTTAB(0,1);S%;TAB(7,1);E%;T
AB(12,1);"50";TAB(16,1);H%(1)
680 GCOL0,2:MOVE 0,0:MOVE0,512:PLOT 85,1280
,0:PLOT 85,1280,512
690 VDUS
700 GCOL 0,6:FOR X=0 TO 19 STEP2
710 MOVE X*64,704:PRINTF#:NEXT
720 F%=50:X%=0:Y%=320:J%=2:FX%=1280:FY%=788
730 MOVE X%,Y%:PRINTR#
740 PROCnew_egg

```

```

750 MOVE X%,Y%:PRINTR#
760 FOR A=1 TO 15:VDU19,A,A:0:0:0:NEXT
770 ENDPROC
780 DEF PROCmusic
790 ?&220=0:?&221=9:?&71=0:?&70=0:N=&70:R=&
A00:Pp=&84:?&80=1:?&81=0:?&82=3:?&83=0:M=106
800 FOR PASS=0 TO 2 STEP 2
810 P%=&900
820 [OPT PASS
830 LDA#&80:LDX#250:LDY#&FF:JSR&FFF4:TXA:BE
Q L:LDA N:LDA P,X:STA Pp:LDA P+1,X:STA Pp+2:J
MP No:.L RTS:.No LDX#&80:LDY#0:LDA#7:JSR&FFF1
:INC N:INC N:LDA N:LDA N:CMP#M:BEQ Ne:RTS:.Ne
LDA#0:STA N:RTS
840 J
850 NEXT
860 RESTORE 880
870 FOR A=0 TO 104 STEP2:READ F,H:A?P=F+20:
A?(P+1)=H*1.5:NEXT
880 DATA 5,4,41,4,5,4,41,4,5,2,41,14,41,2,4
1,2,41,2,41,2,33,4,33,4,25,16,5,4,41,4,5,4,41
,4,5,2,41,14,33,2,33,2,33,2,41,2,49,4,33,4,53
,16,5,4,41,4,5,4,41,4,5,2,41,14,41,2,41,2,41,
2,41,2,33,4,33,4,25,16,25,4,25,4,13,4,-3,4,5,
4,9,4,13,8
890 DATA 5,2,5,2,5,2,5,2,5,4,33,4,25,16
900 ENDPROC
910 DEF PROCnew_egg
920 MOVE X%,Y%:PRINTB#:MOVE X%,Y%:IF J%=1 P
RINTL# ELSE PRINT R#
930 EX%=RND(19)*64:EY%=RND(16)*32:IF (EX%=X%
OR EX%=X%+64) AND (EY%=Y% OR EY%=Y%-32) GOTO
930
940 MOVE EX%,EY%:PRINT#
950 SOUND 2,2,53,1
960 VDU4:PRINTTAB(0,1);S%;TAB(7,1);:IF E%<1
0 PRINT;"0";
970 PRINT;E%:VDUS
980 ENDPROC
990 DEFPROCthrow
1000 IF E%=0 ENDPROC
1010 FOR TY%=Y% TO FY% STEP32
1020 MOVE X%,TY%:PRINTK#
1030 SOUND 3,-15,TY%,1
1040 FOR B=1 TO 50:NEXT
1050 MOVE X%,TY%:PRINTK#
1060 NEXT
1070 E%=E%-1:VDU4:PRINTTAB(7,1);:IF E%<10 PR
INT;"0";E% ELSE PRINT ;E%
1080 VDUS
1090 IF X%=FX% ELSE ENDPROC
1100 FOR TY%=FY% TO Y% STEP-32
1110 MOVE X%,TY%:PRINTZ#
1120 SOUND 3,-15,TY%/10,1
1130 FOR B=1 TO 60:NEXT
1140 MOVE X%,TY%:PRINTZ#
1150 NEXT
1160 F%=F%+5:VDU4:PRINTTAB(12,1);F%:VDUS
1170 ENDPROC
1180 *FX13,4
1190 *FX15
1200 MODE7
1210 PROChigh
1220 GOTO90
1230 DEF PROChigh
1240 IF S%<=H%(5) GOTO 1390
1250 PRINT""TAB(4);CHR#129;CHR#141;"WELL D
ONE !""TAB(4);CHR#130;CHR#141;"WELL DONE !"
1260 V%=0
1270 REPEAT V%=V%+1:UNTIL S%>H%(V%)
1280 PRINT""TAB(4);CHR#131;CHR#141;"YOUR S
CORE IS RANKED ";V%TAB(4);CHR#133;CHR#141;"Y
OUR SCORE IS RANKED ";V%
1290 PRINT""CHR#132;CHR#141;TAB(6)"ENTER Y
OUR NAME""CHR#132;CHR#141;TAB(6)"ENTER YOUR N
AME"
1300 PRINT""CHR#134;TAB(6);"J ";
1310 FOR A=5 TO V% STEP-1:N%(A)=N%(A-1):H%(A)

```



```

)=H%(A-1):NEXT
1320 H%(V%)=S%:N$(V%)=""
1330 *FX15
1340 A=GET:IF A=127 AND N$(V%)="" VDU7:GOTO1
340
1350 IF A=127 N$(V%)=LEFT$(N$(V%),LENN$(V%)-
1):VDUA:GOTO1340
1360 IF A=13 GOTO 1390
1370 IF LENN$(V%)>19 VDU7:GOTO 1340
1380 N$(V%)=N$(V%)+CHR$(A):VDUA:GOTO1340
1390 CLS
1400 VDU134,157,13,10
1410 FOR A=1 TO 2:VDU134,157,132,141:PRINTTA
B(4)"C H I C K E N   F E E D":NEXT
1420 VDU134,157,13,10
1430 PRINTCHR#129:TAB(12):"By Stephen Gray"
1440 FOR A=1 TO 5:PRINT'CHR#141;A;,H%(A);"
";N$(A)'CHR#141;A;,H%(A);" ";N$(A):NEXT
1450 PRINT'CHR#133:TAB(8)"Press <SPACE> to
start":
1460 *FX15,1
1470 REPEAT UNTILINKEY(0)=32
1480 ENDPROC
1490 DEF PROCinstruct

```

```

1500 FOR A=1 TO 2:PRINTCHR#129;CHR#141:TAB(1
0)"CHICKEN FEED":NEXT
1510 PRINT'CHR#130:TAB(9):"By Stephen Gray"
1520 PRINT'" You must run around the farm
yard , collecting the eggs . Your food suppl
y is constantly running out , and to get fi
ve units more , you can throw your eggs up
to the farmer on the fence ."
1530 PRINT'" The game ends when you run
out of food ."'CHR#130;"KEYS"'CHR#131;"Z-l
eft X-right *-up ?-down"'CHR#131;"RETURN-
throw DELETE-freeze"'CHR#131;"COPY-continue
"
1540 PRINT'CHR#134;"Press SPACE when ready"
1550 REPEAT UNTIL INKEY(-99)
1560 ENDPROC
1570 DEF PROCfreeze
1580 FT=TIME
1590 *FX13,4
1600 *FX15
1610 REPEAT UNTIL INKEY(-106)
1620 ?N=0:*FX14,4
1630 TIME=FT
1640 ENDPROC

```



Programs are always supplied on cassette and are accompanied by full details of the program variables, how the program works and any hints on conversion you can offer. Please type these details double spaced. Listings are helpful but not essential. What is vital is that the programs should be completely error free, so please double check.

Always use a coupon firmly fixed to the back of your envelope, and fully complete and enclose the cassette inlay card.

We are particularly interested in programs with less than 100 actual lines of BASIC. All submissions are acknowledged.

**Send your
programs to
HCW!**

Use this cassette inlay card for your program

Name _____

Address _____

Expansion needed _____

Special loading instructions _____

Program title _____

Machine _____

HOME COMPUTING WEEKLY

Program submission _____

Complete this coupon and stick it firmly on the back of your envelope

Name _____

Address _____

Program title _____

Machine _____

Chris Greet of Toshiba took Dave Carlos around the feature exhibit of the PCW show — a vision of the home of the future

FUTURE HOME



music synthesiser. Connect the keyboard and play your music — your way — with over sixty voices and high quality sound.

Master music making on your MSX

The feature of this year's show was "The Home of the Future" set up and manned by Toshiba.

As you might have expected there were a few MSX computers on the stand but they weren't the features causing the greatest interest. This accolade was reserved for the interactive video disc system.

Although this is based on technology developed a number of years ago the combination of

video images from disc and those produced by a computer, gives a quality of graphics that is impossible using the current generation of computers. Chris Greet of Toshiba admitted that the equipment isn't available in this country yet, but is on sale in Japan. The software is quite rare at the moment but the games that were displayed at the show were very impressive with the joystick controlling your position in space. The system is

fairly costly and is unlikely to bring the best arcade games into the home for the majority of teenage players for quite some time.

Moving around the stand we came to the digital television which has a number of possible applications in entertainment terms. The basis of the TV is that it receives its signals as numbers and this means that by using simple, or clever maths — depending how numerate you



COMPACT DISC WITH STILL PICTURE

Compact Disc doesn't just mean high quality sound. The enormous storage capacity and quality of its laser based reproduction has great potential. Imagine storing the Encyclopedia Britannica on Compact Disc. Choose your subject — look at the picture — hear the narration.

See me, hear me CD

DIGITAL T.V.

Digital Processing of TV signal means viewing flexibility. Picture on Picture — with BBC, whilst checking programme on ITV. Eventually the flexibility offered by Digital TV will bring Slow Motion, Zoom, Multi Picture — all on live transmission.



Look two picture — one screen

video recorder to turn themselves on or off from a single simple panel set into the wall or a work surface.

Another panel of the stand illustrated the Lithium battery smart card. Unlike the software card we featured in earlier issues of HCW the card comprises a battery. This means that the card can be used for automatic transfer of funds from your bank account to another. This could mean the end of cheques as we know them! Ah!

The other sections of the exhibit all featured MSX computers in one way or another. The most obvious use of the computer was as a synthesiser with a plug in keyboard and cartridge software. The range of sounds that are possible using such a system are amazing and whilst they may not replace the professional Fairlights, they are perfectly adequate for the home musician. At less than £500, including the computer, they are likely to sell quite well to the real enthusiast.

It was also interesting to see a Compact Disc player attached to an MSX machine. This disc wasn't just playing music though — it was also providing the pictures. Recorded on the disc were a number of high resolution screens which were transferred into the computer as required. At the moment the technology is limited to read-only operation but Chris believes that the read and write laser disc is not too far away and when this becomes a reality it might be possible to replace delicate floppy disc drives with more stable and faster laser drives.

The final section of the stand was devoted to MSX and its future. There was a Toshiba micro running Bank Street Writer a sophisticated word processor but I noticed at least one visitor taking out the cartridge and programming the machine in BASIC.

The Toshiba HX23 was also shown for the first time at a consumer show. This machine is developed to the new MSX enhanced standard with better graphics and greater memory power. The graphics really are exceptional and far better than any current home computer. It remains to be seen if the companies price the new machines in such a way that they can become a major force in the home computer scene.

HX23 The Future Generation of MSX Computing

More power —
More versatility —
More fun —
More usefulness —



MSX enhanced with super graphics

HOME CONTROL
The complete Home Control System.



Simple home control

are, the picture can be transformed in a number of ways.

The set on demonstration could display two pictures simultaneously and by means of a simple remote control unit change the position and size of the images at will. Chris believes that this is just a start and that before very long we will have computers built in to the base of

our digital TVs.

This prospect opens up the world of home control which was covered by another of Toshiba's exhibits. Although very few of the possible applications have yet been tried the technology exists which will allow a single computer, perhaps under a TV, to control all the major home appliances.

The basis of the control is a master panel connected to the computer system. Chris told me that this needed to be installed by a dealer but that as soon as infra-red control became more simple it might be possible to simply place units into the rooms concerned. Just imagine being able to set the cooker, coffee machine, lights and

HOME COMPUTING WEEKLY CLASSIFIED

Lineage:
35p per word

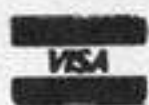

01-437 0699
EXT 322.

Semi display: £7.10 per single column centimetre
Ring for information on series bookings discounts.

Send your requirements to:
David Horne
ASP LTD.
1 Golden Square,
London W1R 3AB

All advertisements in this section must be prepaid.
Advertisements are accepted subject to the terms and conditions printed on the advertisement rate card (available on request).

Accessories

MAPMAKER

Simply the best way of making adventure maps. Write on/wipe off.

A3 size 420 x 297mm.

White PVC screen printed with a blue grid of 11 x 13 boxes.

Price includes special pen.

Send ch/PO for £4.48 to

MAPIT, 166 ROBERT ST,
Ynysybwl, Mid-Glamorgan,
CF37 3E

Duplication

Jbs records COMPUTER PROGRAMS

REAL-TIME or (Slow) HIGH-SPEED Professional Cassette Duplication and Blanks 1 - 1000+. Computer printed Cassette Labels. BBC Disk Duplication and Unformatted Disks 1 - 500+. Fast security delivery service.

Jbs records - a division of
FILTERBOND LTD, 19 Sadlers Way,
Hertford SG14 2DZ 0992-551188

For Hire

Hire & Exchange Software.

Exchange your software! Phone or send list of your software and ask for details. Software hire! No membership charge. P&P free. Hire tapes from £1.50. Phone for details.

T & P Software, 4 Maine Road,
Newland, Drax, Selby, North Yorks.
Tel: 0757 618007.

To hire a computer and/or peripherals by the week or month, please ring 01-607 0157 or 01-997 6457. We specialise in BBC and Apricot computers. Computer Hire Services 294a Caledonian Road, London N1 1BA

ORIC, ATMOS, COMMODORE 64, LYNX SOFTWARE LIBRARY

Over 150 Oric and 200 Commodore 64 titles.

Stamp for details:-

Les Wilson 100 Blenheim
Walk, Corby, Northants.

For Sale

Sinclair QL. Standard. Usual extras Still boxed. Further extras: Four empty cartridges, magazines worth £20.00, printer cable. Another computer with four games. All £190.00. Phone: Upper Warlingham (05832) 3834 7-7pm or weekends.

Libraries

BBC B/Electron/Dragon software library - Membership £5.00. - Tapes 1 (+30p P&P). Stamp for details. E. Tucker, (H) 58, Blenheim Walk, Corby, Northants.

Software

FULL FEATURE FRUIT MACHINE game for 48K Spectrum including: hold, (auto)nudge, roulette style gamble, super series, rewind, stop-a-win, 4 reels, top-up etc. ONLY £5 (professionally duplicated). Also available: C-20 blank tapes £5 for 20. **VIDEO LEISURE, 7 Halfleet,**
Market Deeping, Peterborough PE6 8DB

THE CHART PROGRAM (BBC B) more details from **J..HUGHES 42**
CYPRUS ST* BETHNAL GREEN
LONDON E2 ONN..

Halley's Comet. Computer planetarium for the Spectrum 48K £8.95. Contact: Anima Scientific Computing, 23 Crawley Avenue, Hebburn, Tyne & Wear NE31 2LT

TI-99/4A Software

TEXAS 99/4A Imported Superior Quality

CHESS*	£9.95
5-GAME VALUEPACK	£5.95
GHOSTHUNTERS*	£9.95
MR ROBOT	£5.95
PIRATE RACING*	£5.95

SPECIAL OFFER:

SPOOK-MAN only £2.95

* = requires Extended Basic

P&P included. Overseas add £1

Send cheque/PO to:

CINTRONICS LTD, Lonsto House,
1, 2 & 3 Princes Lane,
London N10 3LU

For a full list of our titles send SAE.

**ONE DAY ALL
THIS SPACE
COULD BE YOURS
PHONE DAVE
01 437 0699 ex322**

Repairs 'n' Spares Register

COMMODORE REPAIRS

Commodore repairs by Commodore approved engineers. Repair prices VIC-20 modulator £8.00, VIC-20 £15, CBM 64 from £20, C2N from £9.00, 1541 from £20, C64 PSU £13.50. Spectrum £16.50, Dragon £32, Electrons, Atari.

For more information SAE or telephone:

G C Bunce & Son, 36 Burlington Road,
Burnham, Bucks SL1 7BQ
Tel: (06286) 61696

Computer Repairs in Hampshire
Spectrum £19.95 inc VAT, p&p,
BBC, CBM 64 from £19.95.
Also Atari and VIC-20.

COMPUTER CARE SOUTH
149 KINGSTON ROAD,
PORTSMOUTH,
HAMPSHIRE
Tel: 0705 825110

COMPUTER REPAIRS IN SOUTHEND

Spectrum/Plus	£19.95
Spectrum K/B faults	£12.95
Interface 1/2	£14.95
New Spectrum power supply	£9.95
C64/Vic 20	from £12.95

Above prices include parts,
post & packing.

All repairs are guaranteed 3 months.
Call in or phone for more details.

MINNIE MICRO ELECTRONICS
12 EASTERN ESPLANADE,
SOUTHEND, ESSEX.
Tel: (0702) 62033/615809

OPEN 7 DAYS A WEEK

CLASSIFIED ADVERTISING TERMS & CONDITIONS

Our terms for new advertisers (semi-display and lineage) are strictly proforma payments until satisfactory reference can be taken up (excluding recognised advertising agencies). Cheques and PO's should be crossed and made payable to:

ARGUS SPECIALIST PUBLICATIONS LTD.,

and send together with the advertisement to:

THE CLASSIFIED DEPT., L/H,
NO: 1 GOLDEN SQUARE, LONDON,
W1R 3AB.

There are no reimbursements for cancellations. Advertisements arriving too late for a particular issue will be inserted in the following issue unless accompanied by instructions to the contrary.

All advertising sales are subject to Government regulations concerning VAT. Advertisers are responsible for complying with the various legal requirements in force eg: The Trade Description Act, Sex Discrimination Act & The Business Advertisements (Disclosure) Order 1977.
FULL TERMS & CONDITIONS OF ADVERTISING AVAILABLE ON REQUEST.

COMPUTER REPAIRS

We are the experts, having serviced Sinclair computers since the introduction of the ZX80.

Don't waste money on estimates - we repair Sinclair computers at price quoted (inclusive parts, labour, postage, VAT, irrespective of fault. No hidden charges. Repairs guaranteed for 3 months.

Spectrum	£18.75 inc parts
ZX81	£11.50 inc parts
16 KRam	£9.95 inc parts
Microdrive	£15.95 inc parts
Interface 1-11	£18.75 inc parts

also

BBC	£22.00 + parts
Electron	£19.95 + parts
XX Memory Expansion Kit	£15.95

Computer Retailers please phone for Special Trade Price.

Call or send with cheque or P.O.
T.V. Services of Cambridge Ltd.
French's Road, Cambridge, CB4 3NP
Tel. 0223 311371

CHILTERN COMPUTER CENTRE

Fast reliable service

Spectrum £18 incl.

We also repair BBC, Commodore, Oric, Dragon disc drives and printers.

Ring 0582 455684 for details.

Send computer with details incl cheque to:

Newcrown Computers Ltd (HCW),
76B Dallow Road,
Luton, Beds



CLASSIFIED RING

01-437 0699

The contents of this publication, including all articles, plans, drawings and programs and all copyright and all other intellectual property rights therein belong to Argus Specialist Publications Ltd. All rights conferred by the Law of Copyright and other intellectual property rights and by virtue of international copyright conventions are specifically reserved to Argus Specialist Publications Ltd and any reproduction requires the prior written consent of the company.
© 1985 Argus Specialist Publications Ltd

SSN0264-4991

CLASSIFIED ADVERTISEMENT — ORDER FORM

1	2	3
4	5	6
7	8	9
10	11	12
13	14	15

Please place my advert in Home Computing Weekly for _____ weeks.
Please indicate number of insertions required.

Would advertisers also add 15% VAT

ONLY 35p per word (minimum charge 15 words)

CLASSIFIED DEPT., HOME COMPUTING WEEKLY,
1 Golden Square, London W1R 3AB
Tel: 01-437 0699

Name

Address

Tei. No. (Day)

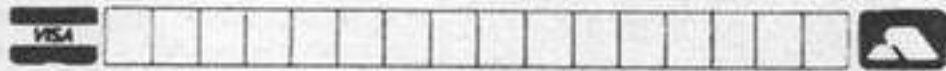

FAST COMPUTER REPAIRS

VIDEO VAULT INTERNATIONAL 10★ REPAIR SERVICE

Spectrums repaired for £19.95 inc. Parts, Insurance and P & P No Hidden Extras.
BBC, Commodore 64, Vic 20, Atari, Quoted for.

Are you fed up with waiting weeks for your Home Computer to be repaired!!!
Why not try the Experts, we offer a full repair service on any Home Computer.
All repairs carry a full 3 months guarantee, plus on every Spectrum repaired we
send you a free game worth £5.95 for your enjoyment and pleasure.

- ★ While you wait Service by Professional Computer Engineers.
- ★ 3 Months written guarantee on all repairs.
- ★ International repair company.
- ★ All computers sent by mail order turned around in 24 hrs.
- ★ Most Spectrums repaired within 45 minutes.
- ★ All Micros insured for return journey.
- ★ Open 7 days a week./Keyboard faults only £8.95
- ★ School repairs undertaken-discounts available.
- ★ Free software with each Spectrum repaired worth £5.95.
- ★ Over 8 years experience working with computers.

ONLY GENUINE SINCLAIR PARTS USED.

Phone today for your free estimate or send your computer to us with £1.75
(UK EIRE I.O.M. C.I.) or £2.40 (Europe/Scandinavia) we will contact you the
same day by phone or 1st class Mail should you require quotation first.

TRADE ENQUIRIES MOST WELCOME. ACCESS WELCOMED
VIDEO VAULT LTD THE LOGICAL CHOICE

VideoVault

Telephone: Glossop (STD 04574) 66555/67761
140 High St. West, Glossop, Derbyshire, England.

N.B.
WE DO NOT CHARGE
AN "AVERAGE PRICE"

FREE GAME WORTH
£5.95 WITH
EACH SPECTRUM
REPAIR.

CLASSIFIED RING 01-437 0699

If an advertisement
is wrong we're here
to put it right.

If you see an advertisement in the press, in print,
on posters or in the cinema which you find
unacceptable, write to us at the address below.

The Advertising Standards Authority. ✓

ASA Ltd, Dept 3 Brook House, Torrington Place, London WC1E 7HN



THE QL RACING GAME!
FROM
ENGLISH SOFTWARE
TEL: 061-835 1358

ENGLISH SOFTWARE
ENGLISH SOFTWARE
ENGLISH SOFTWARE

UnitSoft

AFFORDABLE PRODUCTS (US\$)

UNIT 5
136 INGRAM STREET
GLASGOW G1

COMMODORE 64

- Underworld 7.50
- Sabre Wolf 7.50
- Elite (cass) 11.20
- Elite (disk) 13.45
- Sky Fox (cass) 7.50
- Sky Fox (disk) 9.70
- Tour de France 7.50
- Gt. Road Race 7.50
- Rescue Fractalus 7.50
- On Field F'ball 7.50
- On Court Tennis 7.50
- Barry McGuigan 7.50
- Music Studio 11.20
- Mercenary 7.50
- Dun Darach 7.50
- Rockfords Riot 7.50
- Hypersports 6.95
- F.G.T.H. 7.50
- Nodes of Yesod 7.50
- Exploding Fist 7.50
- Starion 6.70
- Terrormolinos 5.95
- Summer Games II 7.50
- Ghost Chaser 7.50
- Pitstop II 7.50
- Imposs Mission 7.50
- Dough Boy 7.50
- Beach Head II 7.50
- Speed King 7.50
- Thing on a Spring 5.95
- Nick Faldo's Open 7.50
- Theatre of Europe 7.50
- Entombed 7.50
- Blackwiyche 7.50
- Karateka 7.50
- Castles/Dr. Creep 7.50
- Stealth 7.50
- Evil Crown 7.50
- Lode Runner 7.50
- Cauldron 5.99

- Rhupert/Toy Makers .. 7.50
- Schizophrenia 7.50
- Race D'truct Set (d'k) 11.20
- Music C'truct Set (d'k) 11.20
- Mail Order Mons (d'k) 11.20
- 7 Cities of Gold (disk) 11.20
- Int/Karate 5.20
- Cylu 1.85

SPECTRUM

- Fairlight 7.50
- Exploding Fist 6.70
- Nodes of Yesod 7.50
- Starion 7.50
- Southern Belle 5.95
- Pole Position 5.95
- Now Games 6.70
- Terrormolinos 5.95
- F/Warrior 6.70
- F.G.T.H. 7.50
- D.T. Supertest 7.50
- Hypersports 5.95
- World Series B'ball 5.95
- Spy Hunter 5.95
- Frank Bruno 5.20
- The ARTist 9.70
- Nightshade 7.50
- Knightlore 7.50
- Sabre Wolf 7.50
- Alien 8 7.50
- Underworld 7.50
- Cauldron 5.99
- Int/Karate 5.20
- Evil Crown 7.50
- JSW II 5.20
- Dynamite Dan 5.20
- Profanation 5.95
- Dun Darach 7.50
- Grand National 5.20
- Red Moon 5.20
- Red Arrows 6.70
- On the Run 6.70
- Fourth Protocol 9.70
- Cylu 1.85
- Code/Mat II 6.70
- Rhupert/Toy Makers 5.99
- Leonardo 5.90
- Robin/Sherwood 7.50
- Rockford Riot 7.50
- One on One 6.70
- Popeye 5.20
- Nick Faldo's Open 7.50
- Dam Busters 7.50
- Quake Minus One 7.50
- Shadow Fire 7.50
- High/Encounter 5.95
- Monte on the Run 5.20
- Spy v Spy 7.50
- Doom Darks Revenge 7.50
- Wizards Lair 5.95
- Rocco 5.95

AMSTRAD

- Exploding Fist 7.50
- 3D Starstrike 5.50
- Starion 7.50
- Foot/Manager 5.95
- The Hobbit 11.20
- Sir Launcelot 6.95
- Robin/Sherwood 7.50
- Mordons Quest 5.50
- Ghostbusters 8.25
- Master of Lamps 7.50
- Beach Head 7.50
- Sorcery 6.50
- Alien 8 7.50
- Nightlore 7.50
- Jump Jet 7.50
- Project Future 6.50
- Code/Mac II 6.50
- Ring/Darkness 7.50
- Tank Busters 5.95
- View to a Kill 8.25
- Dan Darach 7.50
- Red Moon 5.20
- Red Arrows 7.50
- Confuzion 5.20
- Rocky Horror 6.70
- Frank Bruno 6.50
- Rocco 6.70
- The Quill 12.70
- Wizard's Lair 6.70
- D.T.'s Decathlon 5.20
- Int/Karate 5.20
- Chucky Egg 5.20
- Pyjamarama 6.70
- Manic Miner 6.70
- Smugglers Cove 4.50
- Higgin's Snooker 6.70
- Higgin's Pool 6.70
- Warlord 5.95
- Fighter Pilot 6.70
- Hunchback II 6.70
- Elidon 6.70
- Everyone's A Wally 7.50
- combat Lynx 6.70
- Scrabble 7.50
- Hard Hat Mask 6.70
- F/Diamond 5.95

PERIPHERALS

- Quick Shot II 5.95
- Joycard 5.95
- Datex Microstick 11.50
- GY II Stick-Ams 7.95

Please state name, address and order clearly. Postage included UK. Overseas orders add £1.00 per game. All cheques payable to: Unitsoft

Counting the cost

I have just read the letters page of HCW 126 and once again someone has raised the topic of software piracy. The same old excuse is offered that if prices were lower that people would not copy. I agree that a lot of software is overpriced, especially in my case as I am an Amstrad owner. In the end by the law of economics you only get what you pay for. After all a Mini and a Rolls Royce do the same thing but the time and material put into them make them different.

Budget software is a great idea and Mastertronic are the masters of the lot but another letter on the page proves my point. Someone complained of a poor ending on Action Biker. Perhaps if a bit more money was paid there might have been a better ending, although this is not always the case. It is amazing what some people expect for their £1.99.

People who pirate will copy no matter what the price. To them why pay even £1 for a game when you can pay 50p for a blank tape and copy 4 or 5 games onto it. Being unemployed I just make sure that any software I buy is worth the money I pay for it.

Allan Mayers, Cwmbran

Exit the 664

I write to you as one of the "suckers" who recently purchased an Amstrad CPC 664.

I find it totally unacceptable that I, like a few thousand others, have parted with good money buying a machine which has "died" after just 4 months.

I would hope that the computer press would present a united front to Amstrad in a campaign aimed at persuading them to replace these machines with the "new" CPC 128 and give the "suckers" a fair deal.

I, like many other people, consider their marketing policy to be totally unacceptable and unethical. Indeed, I intend taking this matter up with the Office of Fair Trading in the hope that they too will bring some pressure to bear on Amstrad.

As a serious educational user I find it unbelievable that a company trying to enter the education market should have such a slap-dash approach to sales and customers.

G. Wyllie, Airdrie

Computing in Karachi

Although I am an MSX user HCW is still my favourite magazine. I am a Spectra Video 328 owner and I buy HCW every week and have every copy since Number one. My only complaint is about the front cover which I don't think is good — it is the same as the pages inside it.

I bought the Spectra video because I like space adventures but when I arrived in Pakistan from America I was shocked because you cannot find software here. Terrible isn't it?

Adnan Ahmed Ouseslu, Karachi, Pakistan

Get sharp

I am writing on behalf of the growing community of Sharp MZ 700 owners. I do like the magazine and I think it's reasonably priced but when are you going to start even mentioning the Sharp or have a listing for it now and then?

This past year the MZ 700 has become more popular and I'm sure a lot of people would like to see reviews for it. I am tired of hearing about the Spectrum all the time so please could you give our computer a chance just for once. Also if any reader knows anything about the Sharp could they let me know?

Michael Branwell, Gloucester

Software drought

First let me endorse M. Wong's moan about the lack of software for the Electron. Thousands of people now own Electrons, yet good software is scarce. The micro can handle Elite so what is the problem?

Secondly I would totally agree with the point made that too many games have pathetic endings, notably Code Name Mat, Lords of Time and Knightlore so come on chaps make these games worth finishing.

Next moan — please, please, software authors when converting games from say, C64 to Amstrad don't use Amstrad Mode 0. Colourful it may be, but the graphics are big, fat and totally disgusting. The only good Mode 0 graphics I have seen are those in Sorcery, while games such as Moon Buggy (Anirog), Beach Head (U.S. Gold) and many others have turned out much worse than the 40 column C64 version. Thanks for the excellent magazine.

M. Bannister, Fleet



Handwritten scribbles and signatures.

Home Computing Weekly,
No 1 Golden Square,
London W1R 3AB.

TV's favourites
ORM AND CHEEP
Narrow Squeaks

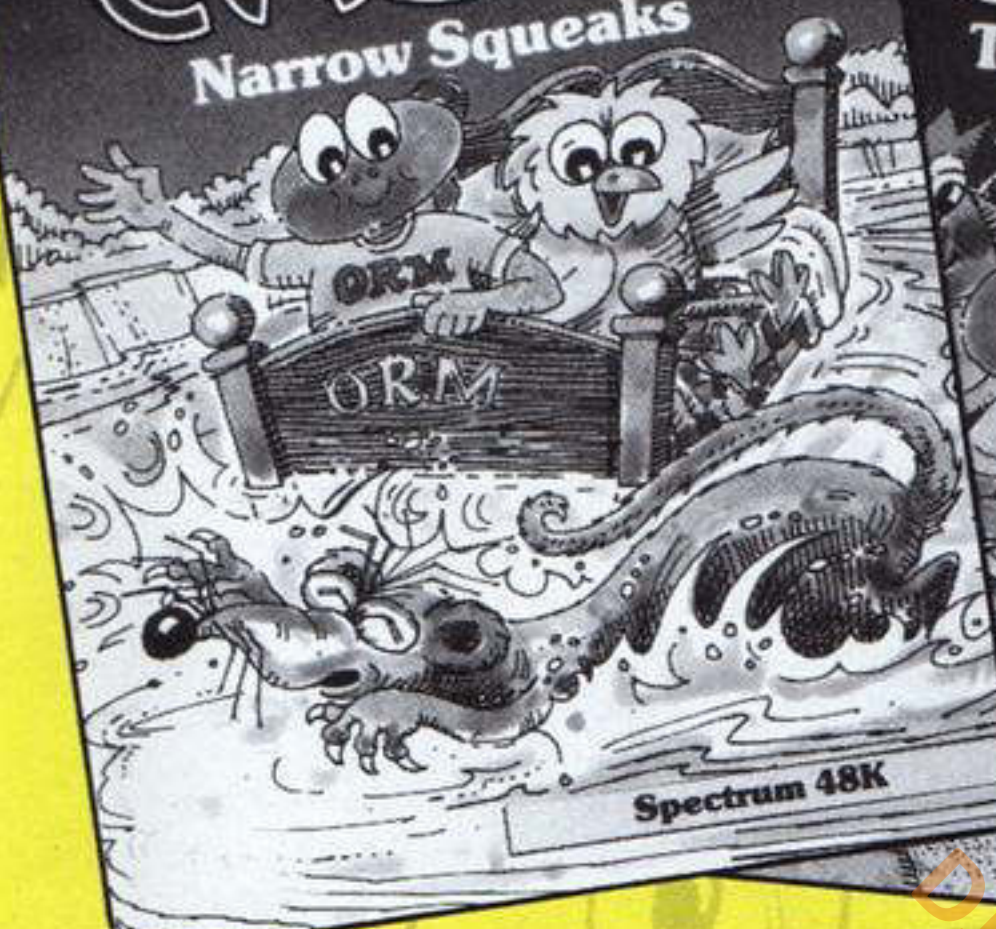

Spectrum 48K

TV's favourites
ORM AND CHEEP
The Birthday Party



Commodore 64

ORM & CHEEP

There are prizes worth hundreds of pounds in this week's competition from Macmillan Software featuring Orm and Cheep

There's a trip to London, all expenses paid by Macmillan Software, for three lucky HCW readers this week.

Whilst you are in the big city there will be a trip to a television studio to see a children's TV programme being made. This is all to celebrate the release of the new Orm and Cheep computer games from Macmillan.

Orm, the worm, and Cheep, the bird, are the stars of a children's television series which was so popular that 72% of the 4-15 year old audience watched the first series. Now these lovable creatures have made it to the computer screen in two arcade style adventures.

The first game is just one long party, or should we say one long trip to a party, for Cheep is trying to help his friends to the fun and games through Mole's dark tunnels. There are enemies for Cheep to avoid too so life is never easy but the party is its own reward.

The other game is Narrow Squeaks in which Rat, Crow and Cat, Orm and Cheep's enemies attack them at every opportunity and they end up having one narrow escape after

another. There are four scenarios in this game each with its own problems and puzzles. Both games will appeal to everyone from 6 to 60 as clever programming allows the game to adjust itself to the player and make life harder or more simple accordingly.

The first prize is for three people to visit the studio and all the travel and other expenses will be met by Macmillan but we regret that this can only be for UK residents for obvious reasons.

There are five second prizes of an Orm and Cheep T Shirt and a game and 20 runners up

prizes of Orm and Cheep games. All you have to do to win one of these prizes is think of a narrow squeak that Orm and Cheep might have to face. Then draw a picture of your idea so that we can see how difficult it is to get out of.

There is no need to be a good artist — we are quite happy to have stick birds and stick worms in the pics — it's the ideas that we are looking for!

So get out your pencils and create a situation that will cause problems and you could be playing Orm and Cheep as one of our winners!

How to enter

Think of a sticky situation that might occur in the game Narrow Squeaks and draw us a simple picture of the problem. There is no need to take a great deal of time over the drawing — it's the idea that will count.

You might also send a short, less than 50 word, description of the problem and how it might be solved — but a simple picture is essential.

Send your picture, and description — if any, with the coupon attached to your entry to Orm and Cheep Competition, Home Computing Weekly, No 1 Golden Square, London W1R 3AB to arrive not later than first post on Friday 11 October 1985.

The rules

- Entries will not be accepted from employees of Macmillan Software, Argus Specialist Publications and Alabaster Passmore & Sons. This restriction also applies to employee's families and agents of the companies.
- The How to enter section forms part of the rules.
- The editor's decision is final and no correspondence can be entered into.
- The first prize can only be awarded to residents of the United Kingdom travelling from UK locations.

Macmillan Competition

Entry Coupon

Name _____

Address _____

post code _____

Machine owned: Spectrum/C64

Complete clearly and fully — if you are a winner this will act as a label for your prize. Post to: Orm and Cheep, Home Computing Weekly, No 1 Golden Square, London W1R 3AB. Closing date first post on Friday 11th October 1985.

Terrific, fantastic, brilliant . . .

Some reader's raves beginning with Ian Longden from Hinckley who has been "totally amazed, flabbergasted and knocked out" by The Way of the Exploding Fist from

Melbourne House. Paul and Glenn Gibney from Carrickfergus, Co Antrim are in the grip of Hypersports fever. "We give it ten out of ten. The graphics are terrific and everyone of the six events have to be tackled completely differently."

PEEKing screens

Some people, like myself may have found it a nuisance not being able to PEEK the screen on the Amstrad to detect collisions etc. This is because of the nature of the ROM and RAM in this area. They both occupy the same area in memory but are switched as necessary. When the area is POKED the RAM is switched in (the screen memory is RAM) and when it is PEEKed the ROM is switched in.

A way to overcome the problem is to use the ROM/RAM switching firmware routine for machine code. This is not as complicated as it sounds — it amounts to a seven byte routine, easily POKEd into memory.

This is the routine

```
CALL 60 BB 3000 CD 60 BB
LD (char),A 3000 32 37 75
RET 30006 C9
```

where char is the next location after the routine for placing the result.

To set up the routine just include the line

```
FOR X=30000 TO 30006:
READ D:POKE X,D:
NEXT:DATA 205,96,187,50,
55,117,201
```

near the start of your program and use

```
LOCATE X,Y:CALL 30000:
AS=CHRS (PEEK(30007))
```

to return the character at the cursor position (X,Y) into AS or whatever you decide to call this variable.

Substituting the last part of the line for

```
A=PEEK(30007)
```

will return the ASCII code rather than the character.

Highlights on the CPC464

To make debugging programs easier on the AMSTRAD type in listings with the "CAPS LOCK" off. When the program is listed a lot of errors will remain in lower case whilst the correct parts of the program are put into UPPER CASE by the system thus highlighting errors in the listing.

J W Constable, London W3

PETER GODSWORTH.

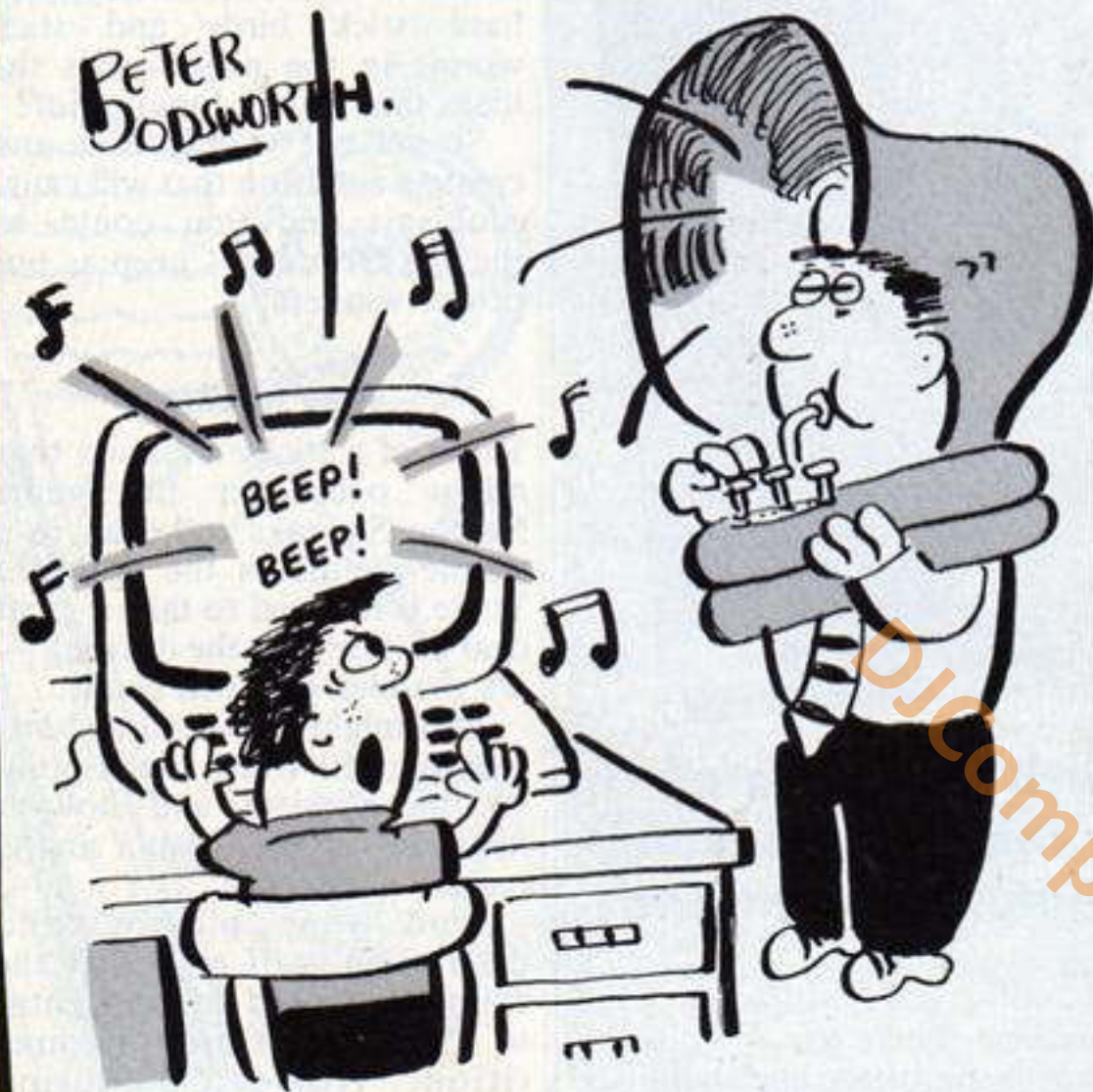

"Thanks, Dad! But I don't need accompaniment."

Solution to last weeks puzzle

XXX0XXX. If the squares are numbered consecutively from top to bottom 1,2,3... along the row then a plant has thrived in every square which is not a prime number!

Lost for words...

In this computer word-search from Richard Burton, Cornwall, there are 64 names of computers and computer manufacturers. Richard suggests that the easiest way to note the answers is to write them and their locations on a separate piece of paper (i.e. C13-Apple) — not to mark them on the actual word-square.

A	B	C	D	E	F	G	H	I	J	K	L	M	N	O	P	Q	R	S	T	U	V	W	X	Y		
1	I	L	Q	S	R	E	S	E	A	R	C	H	M	A	C	H	I	N	E	S	I	R	I	U	S	Y
2	T	I	J	N	A	S	C	O	M	R	I	A	L	C	N	I	S	O	A	C	O	R	N	D	K	
3	S	J	E	S	I	R	P	R	E	T	N	E	N	O	Y	T	H	G	I	E	X	Z	N	O	J	
4	A	X	A	J	O	N	O	S	N	O	S	P	E	O	P	A	M	Q	R	S	D	A	R	U	U	
5	X	G	I	T	T	E	V	I	L	O	V	D	E	N	Q	I	S	T	Q	R	T	P	R	T	P	
6	E	Z	M	C	A	H	A	M	A	Y	I	N	E	U	T	P	V	L	A	E	Y	I	P	K	I	
7	T	E	Z	S	H	A	R	P	Z	V	R	W	A	S	Z	T	I	K	L	A	S	O	R	D	T	
8	O	N	D	A	R	T	S	M	A	O	B	R	U	E	O	S	C	E	K	P	M	O	E	P	E	
9	R	I	N	E	C	A	M	R	B	R	I	B	R	S	N	A	T	A	M	A	X	T	C	I	R	
10	I	T	E	S	N	X	T	S	A	U	I	O	H	O	P	C	W	S	C	N	T	R	N	E	A	
11	C	H	J	Y	T	C	O	I	S	S	D	I	G	T	O	N	E	I	Y	N	O	S	A	D	C	
12	E	V	O	S	E	L	N	K	H	O	B	A	T	L	I	A	N	L	D	A	T	P	V	P	E	
13	C	P	A	P	P	L	E	I	M	A	R	E	B	L	A	T	T	N	G	E	L	E	D	I	X	
14	A	W	S	P	O	T	A	M	W	D	L	Y	R	E	O	S	Y	S	I	O	V	C	A	P	O	
15	N	A	P	R	I	C	O	T	R	W	A	E	I	S	I	E	E	N	T	I	S	T	S	E	F	
16	O	N	O	R	T	C	E	L	E	S	M	G	H	P	R	N	L	R	E	D	O	R	O	R	I	
17	N	G	Z	O	R	B	A	H	N	H	C	E	T	O	M	E	M	F	M	F	U	C	B	B		
18	M	S	X	I	I	R	A	T	A	T	M	O	S	X	M	O	C	G	W	I	T	M	H	F	M	



Shadow of the UNICORN

THE FIRST EVER MIKRO-PLUS GAME

Nearly 50% bigger and better game for the Spectrum

Shadow of the Unicorn - a 120 page illustrated book, 64K of programme, and Mikro-Plus interface - all for £14.95

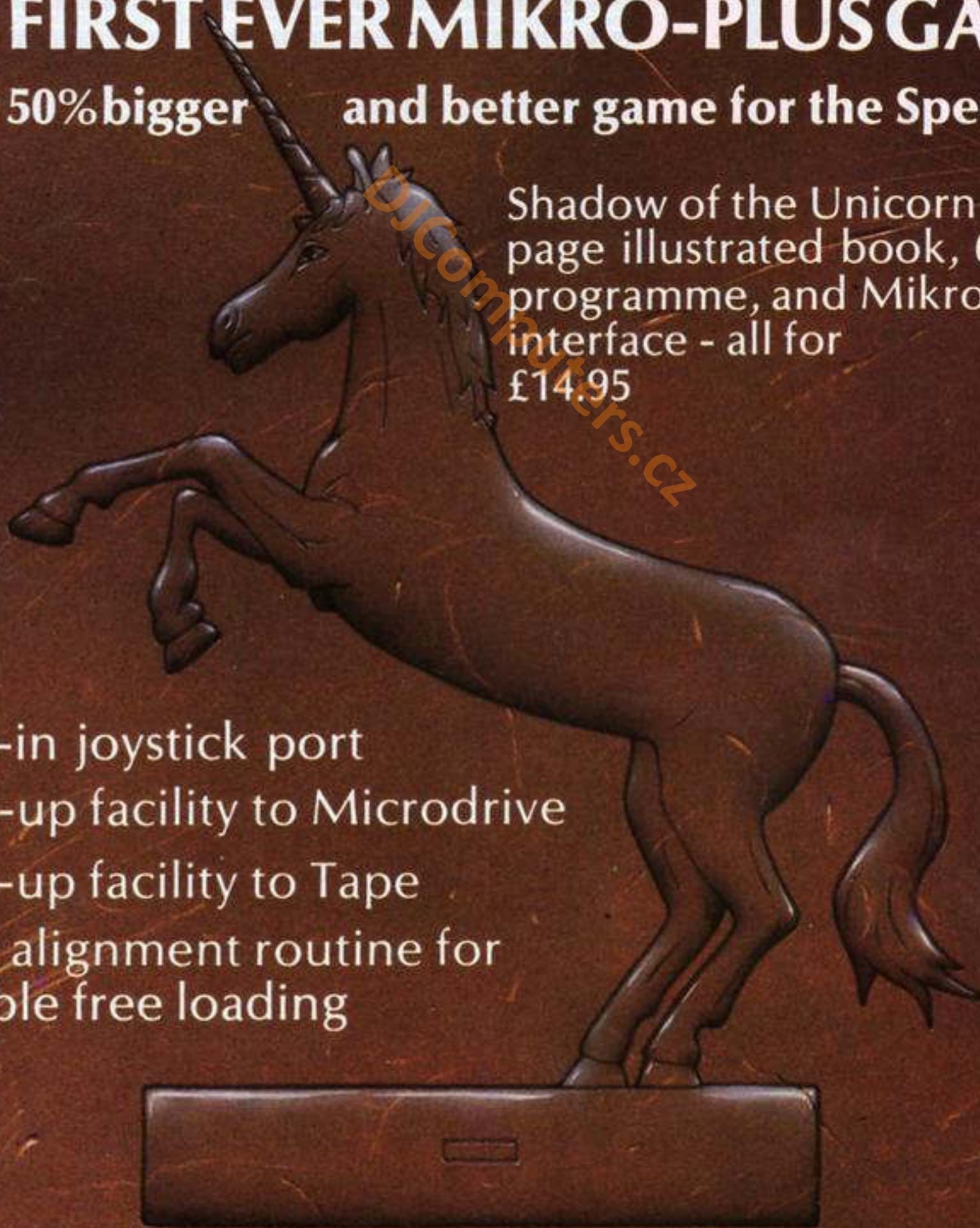

- Built-in joystick port
- Back-up facility to Microdrive
- Back-up facility to Tape
- Tape alignment routine for trouble free loading

RUPERT

and the
TOYMAKER'S PARTY



Jolly old Rupert can walk, jump, leap, climb stairs – and even fly – but can you get him to the party?

32 challenging screens of animation and fun.

QUICKSILVA
The most powerful games in the Universe

Quicksilva Ltd, Liberty House,
222 Regent Street, London W1R 7DB.
Telephone 01-439 0666

£7.99

Rupert Bear © Express Newspapers PLC

Spectrum 48K
CBM64